

Driving the
Future of Mobility
2016 Annual Report





Through leadership and a
commitment to innovation,
Magna continues to be
the go-to industry partner.

DRIVING **EXCELLENCE.**
INSPIRING **INNOVATION.**

Message to Shareholders

Magna is well-positioned with the expertise and global experience to help enable the future of mobility.

2016 was another record-breaking year for Magna, our investors and employees.

We continued to deliver sales and earnings per share growth and stayed focused on executing our strategic plan. Magna has a compelling business model that includes growing at a rate faster than vehicle production, expanding margins over time, generating strong cash flow and delivering solid returns. These elements have allowed us to create value for shareholders, including our employees, for many years and we believe this model will drive our future results as well.

When I reflect on our continued strong performance, it stems from our vision for the industry and our strategic approach which drive Magna's growth in the automotive space.

Magna is:

- Poised for continued above-industry-average growth.
- Best positioned to respond to automotive shifts due to our breadth of technology expertise and business agility.



- Experienced in areas that will define the future of transportation, including safety, electrification, autonomy, new mobility and connectivity.
- Recognized as a world-class manufacturer with a global footprint and expertise to meet customer needs.

Our strong cash flow generation allows us to both invest for future growth and return capital to shareholders.

Growth Product Areas

Our product portfolio is meeting the challenges that come with the transformation of the automotive industry. We expect our highest growth opportunities between now and 2019 to include these five key product areas:

- Demand for Advanced Driver Assistance Systems (ADAS) – the building blocks for autonomous vehicle technology – is expected to continue to grow around the world. Building on our leadership position in cameras, we expect strong sales growth over the



next few years as we offer a full suite of sensing systems – camera, ultrasonic, RADAR and LiDAR – to complement our system integration capability and enable the emerging levels of autonomy.

- Our powertrain business is positioning itself to benefit from the longer-term electrification and fuel efficiency trends in the industry. Over the next three years, the most significant driver of this area is our transmissions business acquired from GETRAG.
- Our body and chassis expertise assists automakers with addressing the increased legislative pressures on carbon emissions. Our ability to design and manufacture lightweight solutions is demonstrated through the use of innovative processes such as high pressure aluminum die-casting, hot forming and advancements in joining of multi-material assemblies.
- We continue to win new business in seating as customers recognize the value of our EZ-Entry mechanism solutions and quick adjust features which differentiate us and give us the ability to deliver on complex projects.
- A key differentiating factor for Magna is our complete vehicle assembly capability. In 2016, we announced new contracts with BMW and Jaguar Land Rover and are well-positioned to support any new players that enter the industry.

Helping Shape Future Mobility

Our industry is rapidly changing and we expect the next decade and beyond to bring an enormous amount of change driven by technological advances. Magna welcomes this change. Our in-depth systems expertise across our broad capabilities gives us holistic vehicle knowledge, and our electronics know-how and flexible operating structure allow us to quickly adapt. This is what differentiates us from our competition. We have a clear understanding of the global trends and how they impact automotive, and we are using that foresight to engineer future systems. We are empowering our employees and partnering with customers, start-ups, and universities to generate innovative ideas and bring them to market. The next 10–15 years will include an influx of autonomous vehicles, electrification, new modes of transportation and the rise of sharing economies. Magna is ready with the expertise and global experience required to help enable the future of mobility.

Thank you to our stakeholders – our investors, our customers, our industry partners and our employees, including those who have joined the Magna family through recent acquisitions – for driving our continued success.

Sincerely,



Don Walker

Chief Executive Officer

Key Figures at-a-Glance



Vince Galifi
Executive Vice-President
and Chief Financial Officer

I am very pleased with our results for 2016, a year in which we posted a number of records, including sales, earnings per share and cash flow from operating activities. We also generated another strong return on shareholders' equity last year. This was achieved even with the acquisition of GETRAG, which was an important investment for the future of Magna.

Our financial strategy of investing in our business, both through capital spending and acquisitions, while at the same time returning capital to shareholders, is unchanged. We recently announced

another increase to our quarterly dividend, making 2017 our eighth consecutive year of such increases.

Going forward, the changing mobility landscape, together with our broad capabilities and ability to commercialize technology, are expected to bring a great deal of opportunity for Magna's continued growth. We remain highly focused on a disciplined approach to investment in order to translate growth into increased returns, margins and free cash flow. Together, these are what we believe make Magna a compelling long-term investment.

SALES
U.S. \$ MILLIONS

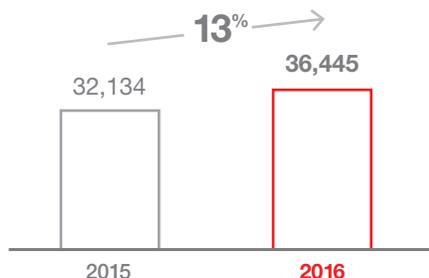

DILUTED EPS FROM CONTINUING OPERATIONS
U.S. \$

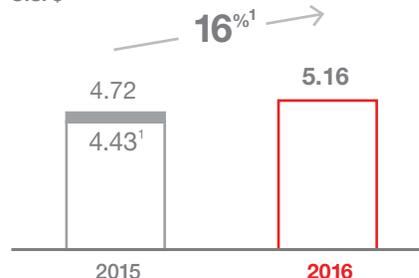

CASH FLOW FROM OPERATING ACTIVITIES
U.S. \$ MILLIONS

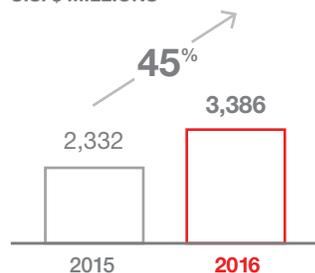

RETURN ON EQUITY²

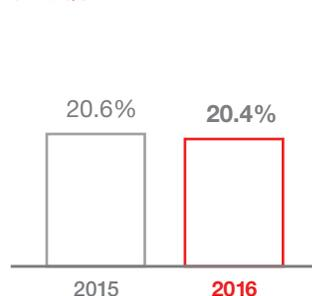

DIVIDENDS PAID PER SHARE
U.S. \$

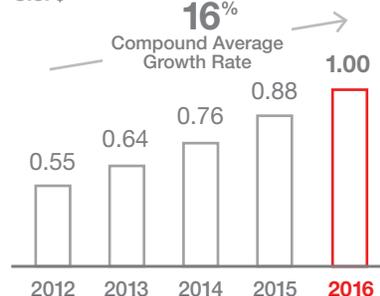

¹ 2015 diluted earnings per share from continuing operations includes \$122 million in after tax gains on disposals, contributing \$0.29 to diluted earnings per share, as discussed in the "Other Expense (Income), net" section of the MD&A on page 11 of this Annual Report. 16% is the percentage change between \$4.43 and \$5.16.

² Return on Equity is a non-GAAP financial measure that has no standardized meaning under U.S. GAAP. Due to the non-standardized definition, it may not be comparable to the calculation of similar measures of other companies. Return on Equity is defined as net income attributable to Magna International Inc. from continuing operations divided by Average Equity. The 2015 calculation excludes the \$122 million gain (after tax) referred to in note 1 above.

A Worldwide Network of World-Class Facilities

With hundreds of facilities in 29 countries, Magna can engineer, manufacture and deliver mobility solutions to create superior value for our customers and the industry.



149 27

78,000 Employees

Canada	50	11	Argentina	3	
United States	55	13	Brazil	11	2
Mexico	30	1			

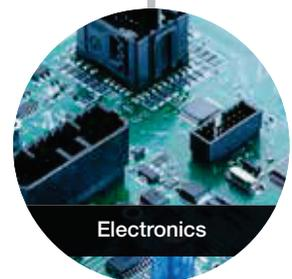

54 25

22,000 Employees

China	40	13	Korea	3	2
India	10	5	Taiwan	1	
Japan	3		Thailand	1	1



114 50

55,000 Employees

Austria	15	8	Italy	4	3
Belgium	1		Poland	7	
Bulgaria	1		Romania	1	
Czech Republic	8	1	Russia	7	
England	9	1	Serbia	1	
France	5	2	Slovak Republic	3	
Germany	42	33	Spain	3	
Hungary	2		Sweden	2	
Ireland	1		Turkey	4	



- Manufacturing / Assembly Facilities
- Engineering / Product Development / Sales Centres

**As of December 31, 2016, manufacturing operations, product development, engineering and sales centres and employee figures include certain equity-accounted operations.*

We are constantly strengthening our capabilities and systems knowledge to meet emerging consumer and industry needs. As we expand, we will continue to help support the future mobility landscape.

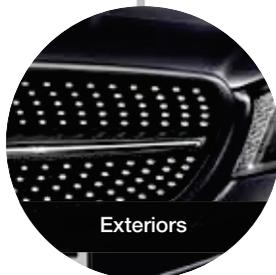

155,000 Employees*

29 Countries*

317 Manufacturing / Assembly Facilities*

102 Engineering / Product Development / Sales Centres*

\$36.4 Billion in Sales



We set production records with Mercedes-Benz, producing 20,000 G-Class in 2016 alone, and more than 250,000 overall.



Magna received top innovation honors from the Society of Plastics Engineers for its active grille shutter technology, carbon fiber hood on the Cadillac ATS-V and CTS-V, and the grille opening reinforcement on the Ford Mustang Shelby Cobra GT350.

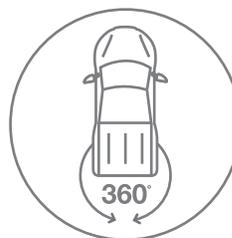

Magna's multi-patented EYERIS® technology supports the Ford Super Duty Trailer Reverse Guidance System to offer drivers a best-in-class 360-degree view, and make trailering safer and more convenient.

Innovation for the Future Mobility Landscape



Swamy Kotagiri
Chief Technology Officer

The pace of innovation in the automotive industry is like nothing we have ever seen before. A new mobility landscape is emerging, creating even more challenges and opportunities in an enlarging ecosystem. For Magna, this means leveraging our culture of innovation and embracing a new level of innovation outreach with universities, start-ups and other industries.

Magna is flexible enough to adapt and grow through the transformation taking place in the automotive industry. It's a two-pronged approach of creating world-class products and systems for global automakers, while also developing new potential technologies for those providing mobility as a service. Spanning across both in the new mobility landscape plays to Magna's strengths.

Through our broad product capabilities we continue to generate opportunities for technology and product advancement, while at the same time positioning ourselves for the expected disruptive changes. Magna has the breadth of capabilities that help tackle the technology challenges of today and define what future systems will be needed 10–15 years from now.

Two key areas where we see this most coming into play include Advanced Driver Assistance Systems (ADAS) and powertrain electrification. ADAS innovations, for example, along with trends towards urbanization and changing demographics, are creating opportunities for new mobility solutions. These solutions include varying levels of autonomy, system integration and connected services with use cases from cities to highway environments. ADAS is setting the pace of technology change in the industry and we are well-positioned with our complete sensor fusion expertise that enables autonomous features.

Electrification is another area that will drive change and opportunity. Our complete-vehicle knowledge supports our electrified powertrain products. These are based on a platform approach to maximize economies of scale, where increasing numbers of vehicles will be produced with a range of hybrid and

As the industry continues to transform, Magna's interaction in the investor and start-up ecosystem is gaining momentum. Such activities ultimately help Magna be at the forefront of innovation in the emerging new mobility landscape.

full-electric propulsion systems. We will leverage these platforms to bring primary powertrain systems and electric AWD systems to our customers and new mobility partners.

Advanced technologies that span across our entire product portfolio go beyond today's owned vehicles to include shared vehicles, ride-hailing services and new forms of short-distance travel that complement public transportation. All these modes of transportation will be smart and connected to provide more convenient, safe and clean mobility. We believe Magna is the best-positioned automotive supplier to deliver innovations for all those who share the road now and in the new mobility landscape.



Our open for business mentality has led to an investment portfolio of 13 new partnerships.



We established an advanced technology advisory board which includes leaders from their respective fields with more than 180 years of collective experience in product innovation and the implementation of new technologies and/or disruptive business models.



Magna's internal employee innovation challenge, which seeks ideas from within the company, serves as an incubator for future developments. In two years, more than 2,000 ideas have been submitted.



From over 800 technology subjects, we have recently investigated more than 86 new potential innovations which have led to 22 active projects.



We have ongoing innovative research projects with several world-renowned universities including MIT and the University of Cambridge.



We have invested in several venture capital organizations, collaborating on future technology ventures.



Smarter



Comfort, Convenience and Connectivity

DESIGNING AND DELIVERING AN INSPIRED, BEST-IN-CLASS CABIN EXPERIENCE

Smart Seats

In an industry as advanced as automotive, balancing complexity with comfort and convenience can be challenging, but at Magna we see it as opportunity. For example, think about automotive seating: for Magna, a seat is a conduit to further the interaction between driver and vehicle, especially as the industry prepares for autonomous driving. Today we are taking our seating expertise to a new level with our health-and-wellness concept. This new technology includes many features, such as the ability to measure the human body and use the data to detect drowsiness and the alertness level of the driver. Increased levels of autonomy will require the vehicle itself to determine if the driver is conditioned to resume control. With more than 25% of accidents around the world reportedly caused by drowsy drivers, this innovation can be a true game-changer for automotive safety.



Cleaner



Efficiency and Sustainability

OPTIMIZING THE USE OF ENERGY TO MEET THE NEEDS OF OUR CUSTOMERS AND OUR PLANET

etelligentDRIVE™

While there is much talk about autonomous-drive and connected-vehicle technologies, automakers are still challenged to improve fuel efficiency. Magna continues to develop innovative powertrain products in response to global trends driven by legislation and consumer preferences to improve the environmental impact of passenger vehicles. New products under development at Magna include powertrain systems and modules for vehicles equipped with 48-volt systems or mild hybrids as well as high-voltage systems including full hybrid, plug-in hybrid and electric vehicle powertrains. And we have further strengthened our ability to provide complete powertrain systems with the acquisition of GETRAG.

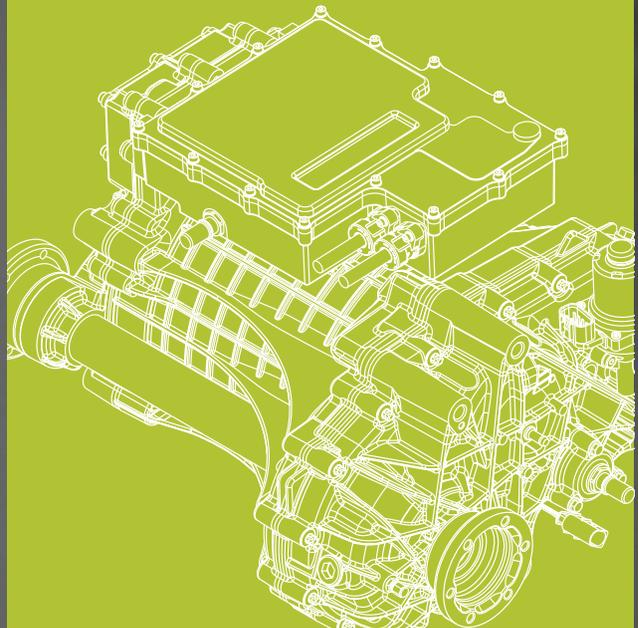

Safer



Active and Passive Safety

ENGINEERING PROTECTION AND PEACE OF MIND FOR ALL WHO SHARE THE ROAD

Autonomous

Vehicle safety is rapidly changing. Providing robust active technologies to avoid an accident, not just protect the driver and passenger after an accident, is the ultimate goal. Today, our electronics capabilities offer features that enable autonomy at different levels. We have developed many of these features on the road today, such as automated emergency braking, trailer-tow assist, lane-departure warning, lane-keep assist and adaptive cruise control. Building on our leadership position in driver assistance systems and complete-vehicle expertise, we have the ability to efficiently combine multiple sensors to develop robust systems as vehicles continue to progress towards full autonomy. We also continue to work with the broader ecosystem to address topics such as data privacy and cyber security. While there is much debate about the future timing of autonomous driving, one thing is clear: Magna intends to play a critical role.

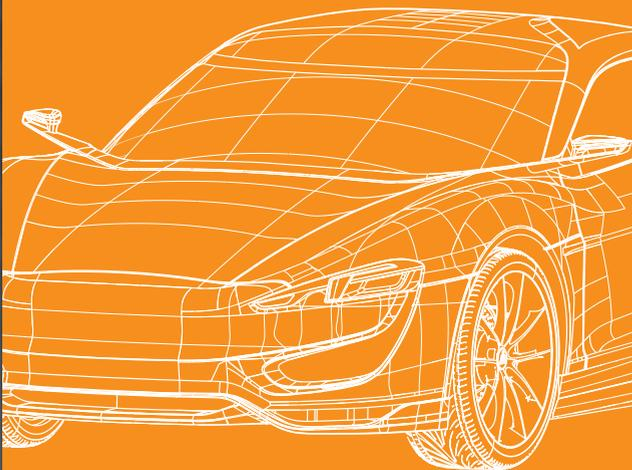

Lighter



Lightweight Material and Science

DRIVING PERFORMANCE AND QUALITY THROUGH INNOVATIVE MASS REDUCTION

Lightweight Door Module

Start from scratch and reimagine a highly engineered product. That's what our Magna team of experts did when it came to the way we think about the design, development and material-use of a vehicle door. Magna, in cooperation with the U.S. Department of Energy and partners FCA and Grupo Antolin, developed a new, ultralight door architecture that achieved roughly 43% mass savings compared to an average current production door. Magna's advanced engineering team combined its unique, full-vehicle perspective on the design with an inventive mix of materials and technology to tackle the challenge of significant weight reduction. This was developed in less than 10 months while keeping the cost within accepted parameters and providing a solution that applies to approximately 70% of the light vehicle market.

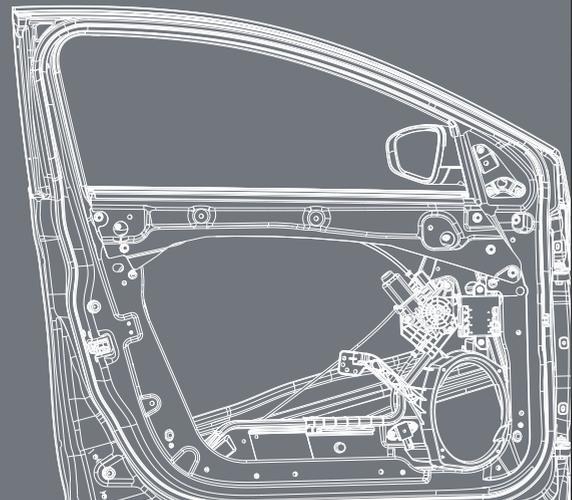

Magna International Inc.

Financial Review 2016

and Other Information

- 1 Management's Discussion and Analysis of Results of Operations and Financial Position
- 25 Reports of Independent Registered Public Accounting Firms
- 27 Consolidated Statements of Income
- 28 Consolidated Statements of Comprehensive Income
- 29 Consolidated Balance Sheets
- 30 Consolidated Statements of Cash Flows
- 31 Consolidated Statements of Changes in Equity
- 32 Notes to the Consolidated Financial Statements
- 61 Supplementary Financial and Share Information

Corporate Directory *(inside back cover)*

Management's Discussion and Analysis of Results of Operations and Financial Position

Unless otherwise noted, all amounts in this Management's Discussion and Analysis of Results of Operations and Financial Position ("MD&A") are in U.S. dollars and all tabular amounts are in millions of U.S. dollars, except per share figures, which are in U.S. dollars. When we use the terms "we", "us", "our" or "Magna", we are referring to Magna International Inc. and its subsidiaries and jointly controlled entities, unless the context otherwise requires.

In 2015, we sold substantially all of our interiors operations (excluding our seating operations). The assets and liabilities, and operating results for the previously reported interiors operations are presented as discontinued operations and have therefore been excluded from both continuing operations and segment results for all periods presented in the attached financial statements. This Management's Discussion and Analysis reflects the results of continuing operations, unless otherwise noted.

This MD&A should be read in conjunction with the audited consolidated financial statements for the year ended December 31, 2016.

This MD&A has been prepared as at March 9, 2017.

Non-GAAP Financial Measures

This MD&A includes the use of Gross margin, Gross margin as a percentage of sales, and Adjusted EBIT. Gross margin is calculated by subtracting Cost of goods sold from Sales, and Gross margin as a percentage of sales is calculated as Gross margin divided by Sales. Adjusted EBIT is calculated by taking net income from continuing operations and adding back income taxes, interest expense, net, and other expense (income), net, as presented on the face of the Consolidated Statements of Income. Gross margin, Gross margin as a percentage of sales and Adjusted EBIT are all non-GAAP financial measures that have no standardized meaning under U.S. GAAP. Due to the non-standardized definition, Gross margin, Gross margin as a percentage of sales and Adjusted EBIT may not be comparable to the calculation of similar measures of other companies. We believe that Gross margin and Gross margin as a percentage of sales facilitate a comparison of our performance with prior periods, and provide investors with a more consistent basis for comparing our results from period to period. Similarly, we believe that Adjusted EBIT provides useful information to our investors as an appropriate measure of our operational performance as it excludes items that are not reflective of ongoing operating profit or loss. The presentation of non-GAAP financial measures should not be considered in isolation or as a substitute for the Company's related financial results prepared in accordance with U.S. GAAP.

HIGHLIGHTS

- We posted new records in total sales, income from continuing operations before income taxes and diluted earnings per share from continuing operations in 2016.
- Total sales increased 13% to \$36.45 billion in 2016, compared to \$32.13 billion in 2015. The 13% increase is substantially higher than the 4% growth in global light vehicle production in 2016.
 - North American production sales increased 9%, compared to North American light vehicle production which increased 2%.
 - European production sales increased 26%, while European light vehicle production was up 2%.
 - Asian production sales rose 38%, compared to a 6% increase in Asian light vehicle production.
- Diluted earnings per share from continuing operations increased 9% to \$5.16, compared to \$4.72 in 2015.
- We generated cash from operating activities of \$3.39 billion, 45% higher than the \$2.33 billion generated in 2015.
- We further invested for our future, including:
 - \$1.93 billion in acquisitions, including the GETRAG Group of Companies ("GETRAG"), one of the world's leading independent suppliers of automotive transmissions, and a leader in the market for dual-clutch transmissions ("DCTs"), a product which is expected to experience high growth over the next decade;
 - \$1.81 billion in fixed asset spending; and
 - \$478 million in investment and other asset spending.
- We returned \$1.30 billion to shareholders, through \$913 million in share repurchases and a further \$385 million in dividends.

OVERVIEW

Our Business⁽¹⁾

We are a leading global automotive supplier with 317 manufacturing operations and 102 product development, engineering and sales centres in 29 countries. We have over 155,000 employees focused on delivering superior value to our customers through innovative products and processes, and world class manufacturing. We have complete vehicle engineering and contract manufacturing expertise, as well as product capabilities which include body, chassis, exterior, seating, powertrain, active driver assistance, vision, closure and roof systems. We also have electronic and software capabilities across many of these areas. Our common shares trade on the Toronto Stock Exchange (MG) and the New York Stock Exchange (MGA). For further information about Magna, visit our website at www.magna.com.

¹ Manufacturing operations, product development, engineering and sales centres and employee figures include certain equity-accounted operations.

INDUSTRY TRENDS AND RISKS

A number of general trends which have been impacting the automotive industry and our business in recent years are expected to continue, including the following:

- evolving concepts of mobility, including shared mobility, particularly in urban areas;
- the growing importance of electronics in the automotive value chain;
- the consolidation of vehicle platforms and proliferation of high-volume platforms supporting multiple vehicles and produced in multiple locations;
- the long-term growth of the automotive industry in China, India, Eastern Europe and other non-traditional markets, including accelerated movement of component and vehicle design, development, engineering and manufacturing to certain of these markets;
- the growth of the B to D vehicle segments (subcompact to mid-size cars and SUVs/CUVs), particularly in developing markets;
- the extent to which innovation in the automotive industry is being driven by governmental regulation of fuel economy and carbon dioxide/greenhouse gas emissions, vehicle safety and vehicle recyclability;
- the growth of cooperative alliances and arrangements among competing automotive OEMs, including shared purchasing of components; joint engine, powertrain and/or platform development; engine, powertrain and platform sharing; and joint vehicle hybridization and electrification initiatives and other forms of cooperation; and
- the exertion of pricing pressure by OEMs.

The following are some of the more significant risks that could affect our ability to achieve our desired results:

- The global automotive industry is cyclical, with the potential for regional differences in timing of expansion and contraction. A worsening of economic or political conditions in North America, Europe or Asia, including through rising interest rates or inflation, rising unemployment, increasing energy prices, declining real estate values, increased volatility in global capital markets, international conflicts, sovereign debt concerns, an increase in protectionist trade measures, collapse of multilateral trade or currency unions and/or other factors, may result in lower consumer confidence. Lower consumer confidence typically results in lower vehicle sales levels, which in turn would typically result in lower vehicle production levels. A significant decline in vehicle production volumes from current levels could have a material adverse effect on our profitability.
- The election of protectionist governments could lead to the withdrawal of some countries from, or renegotiation of, multilateral trade, economic or currency regimes such as the European Union, North American Free Trade Agreement and Trans-Pacific Partnership. The automobile industry is a highly globalized industry which is currently dependent on open borders and the free movement of goods, services, people and capital, particularly in Europe and North America. The continued growth of protectionist sentiments and implementation of measures which impede the free movement of goods, services, people and capital could have a material adverse effect on our operations, profitability or results of operations.
- The uncertainty created by rapidly changing economic or political conditions may impact our ability to plan effectively for our business over the short- and medium-terms. For example, we may establish production capacity at different facilities, including our complete vehicle assembly operations in Austria, based on production volumes which fail to materialize. A material variation between our planning assumptions and actual outcomes could have a material adverse effect on our profitability or financial condition.
- Although our financial results are reported in U.S. dollars, a significant portion of our sales and operating costs are realized in Canadian dollars, euros, British pounds and other currencies. Our profitability is affected by movements of the U.S. dollar against the Canadian dollar, the euro, the British pound and other currencies in which we generate revenues and incur expenses. Significant long-term fluctuations in relative currency values, in particular a significant change in the relative values of the U.S. dollar, Canadian dollar or euro, could have an adverse effect on our profitability and financial condition and any sustained change in such relative currency values could adversely impact our competitiveness in certain geographic regions.
- The automotive industry has in recent years been the subject of increased government enforcement of antitrust and competition laws, particularly by the United States Department of Justice and the European Commission. Antitrust enforcement proceedings can often continue for several years. Where wrongful conduct is found, the relevant antitrust authority can, depending on the jurisdiction, initiate administrative or criminal legal proceedings and impose administrative or criminal fines or penalties.

In September 2014, the Conselho Administrativo de Defesa Economica, Brazil's Federal competition authority, attended at one of our operating divisions in Brazil to obtain information in connection with an ongoing antitrust investigation relating to suppliers of automotive door latches and related products. At this time, management is unable to predict the duration or outcome of the Brazilian investigation, including whether any of our operating divisions will be found liable for any violation of law or the extent or magnitude of any liability, if found to be liable.

Our policy is to comply with all applicable laws, including antitrust and competition laws. We previously initiated a global review focused on antitrust risk led by a team of external counsel. If any antitrust violation is found as a result of such review, a regulatory investigation or otherwise, we could be subject to fines, penalties, restitution settlements and civil, administrative or criminal legal proceedings that could have a material adverse effect on our profitability in the year in which any such fine or penalty is imposed or the outcome of any such proceeding is determined. Additionally, we could be subject to other consequences, including reputational damage, which could have a material adverse effect on our operations.

- The launch of new business is a complex process, the success of which depends on a wide range of factors, including the production readiness of our and our suppliers' manufacturing facilities, as well as factors related to manufacturing processes, tooling, equipment, employees, initial product quality and other factors. Our failure to successfully launch material new or takeover business could have a material adverse effect on our profitability.
- Although we are working to turn around underperforming operating divisions, there is no guarantee that we will be successful in doing so in the short to medium term or that the expected improvements will be fully realized or realized at all. We may also experience underperformance at operating divisions not currently experiencing any issues. Significant underperformance of one or more operating divisions could have a material adverse effect on our profitability and operations.
- We face ongoing pricing pressure from OEMs, including through: long-term supply agreements with mutually agreed price reductions over the life of the agreement; incremental annual price concession demands; pressure to absorb costs related to product design, engineering and tooling and other items previously paid for directly by OEMs; pressure to assume or offset commodities cost increases; and refusal to fully offset inflationary price increases. OEMs possess significant leverage over their suppliers due to their purchasing power and the highly competitive nature of the automotive supply industry. As a result of the broad portfolio of parts we supply to our six largest OEM customers, such customers may be able to exert greater leverage over us as compared to our competitors. We attempt to offset price concessions and costs in a number of ways, including through negotiations with our customers, improved operating efficiencies and cost reduction efforts. Our inability to fully offset price concessions or costs previously paid for by OEMs could have a material adverse effect on our profitability.
- Our customers continue to demand that we bear the cost of the repair and replacement of defective products which are either covered under their warranty or are the subject of a recall by them. Warranty provisions are established based on our best estimate of the amounts necessary to settle existing or probable claims on product defect issues. Recall costs are costs incurred when government regulators and/or our customers decide to recall a product due to a known or suspected performance issue and we are required to participate either voluntarily or involuntarily. Currently, under most customer agreements, we only account for existing or probable warranty claims. Under our powertrain systems programs and certain complete vehicle engineering and assembly contracts, we record an estimate of future warranty-related costs based on the terms of the specific customer agreements and the specific customer's, or our own, warranty experience. While we possess considerable historical warranty and recall data and experience with respect to the products we currently produce, we have little or no warranty and recall data which allows us to establish accurate estimates of, or provisions for, future warranty or recall costs relating to new products, assembly programs or technologies being brought into production or acquired by us. The obligation to repair or replace such products could have a material adverse effect on our profitability and financial condition.
- We intend to continue to pursue acquisitions in those product areas which we have identified as key to our business strategy. However, we may not be able to identify suitable acquisition targets or successfully acquire any suitable targets which we identify. Additionally, we may not be able to successfully integrate or achieve anticipated synergies from those acquisitions which we do complete and/or such acquisitions may be dilutive in the short to medium term, which could have a material adverse effect on our profitability.
- The successful completion of one or more significant acquisitions could increase our risk profile, including through the assumption of incremental regulatory/compliance, pricing, supply chain, commodities, labour relations, litigation, environmental, pensions, warranty, recall, IT, tax or other risks. Although we seek to conduct appropriate levels of due diligence on our acquisition targets, these efforts may not always prove to be sufficient in identifying all risks and liabilities related to the acquisition, including as a result of: limited access to information; time constraints for conducting due diligence; inability to access target company facilities and/or personnel; or other limitations in the due diligence process. Additionally, we may identify risks and liabilities through our acquisition due diligence efforts that we are not able to sufficiently mitigate through appropriate contractual protections. The realization of any such risks could have a material adverse effect on our profitability.
- Although we supply parts to all of the leading OEMs, a significant majority of our sales are to six customers: General Motors, Ford, Fiat Chrysler, Daimler, BMW and Volkswagen. While we have diversified our customer base somewhat in recent years and continue to attempt to further diversify, there is no assurance we will be successful. Shifts in market share away from our top customers could have a material adverse effect on our profitability.
- While we supply parts for a wide variety of vehicles produced globally, we do not supply parts for all vehicles produced, nor is the number or value of parts evenly distributed among the vehicles for which we do supply parts. Shifts in market shares among vehicles or vehicle segments, particularly shifts away from vehicles on which we have significant content and shifts away from vehicle segments in which our sales may be more heavily concentrated, could have a material adverse effect on our profitability.

- In light of the amount of business we currently have with our largest customers in North America and Europe, our opportunities for incremental growth with these customers may be limited. The amount of business we have with Japanese, Korean and Chinese-based OEMs generally lags that of our largest customers, due in part to the existing relationships between such OEMs and their preferred suppliers. There is no certainty that we can achieve growth with Asian-based OEMs, nor that any such growth will offset slower growth we may experience with our largest customers in North America and Europe. As a result, our inability to grow our business with Asian-based OEMs could have a material adverse effect on our profitability.
- While we continue to expand our manufacturing footprint with a view to taking advantage of opportunities in markets such as China, India, Eastern Europe and other non-traditional markets for us, we cannot guarantee that we will be able to fully realize such opportunities. Additionally, the establishment of manufacturing operations in new markets carries its own risks, including those relating to: political, civil and economic instability and uncertainty; corruption risks; high inflation and our ability to recover inflation-related cost increases; trade, customs and tax risks; expropriation risks; currency exchange rates; currency controls; limitations on the repatriation of funds; insufficient infrastructure; competition to attract and retain qualified employees; and other risks associated with conducting business internationally. Expansion of our business in non-traditional markets is an important element of our strategy and, as a result, our exposure to the risks described above may be greater in the future. The likelihood of such occurrences and their potential effect on us vary from country to country and are unpredictable, however, the occurrence of any such risks could have an adverse effect on our operations, financial condition and profitability.
- The automotive supply industry is highly competitive and becoming more so. As a result of our diversified automotive business, some of our competitors have greater market share than we do in product areas such as electronics or geographic regions such as Asia, or increasing market share in such product areas or geographic regions which are experiencing higher growth rates. With the growing importance of electronics in the automotive value chain, a number of electronics and semiconductor companies have entered or expanded their presence in the automotive industry. Additionally, disruptive technology innovators are developing high-value product and service offerings which traditional automotive suppliers may not be able to match. Failure to successfully compete with existing or new competitors, including failure to grow sales of our electronics products or services at or above the rate of growth of electronics content, could have an adverse effect on our operations and profitability.
- While we continue to invest in technology and innovation which we believe will be critical to our long-term growth, the automotive industry is experiencing rapid technological change and significant disruption. Our ability to anticipate changes in technology and to successfully develop and introduce new and enhanced products and/or manufacturing processes on a timely basis will be a significant factor in our ability to remain competitive. If we are unsuccessful or are less successful than our competitors in consistently developing innovative products and/or processes, we may be placed at a competitive disadvantage, which could have a material adverse effect on our profitability and financial condition.
- The risk profile of our business is changing with the growing importance to us of product areas such as powertrain and electronics. As our business evolves, we may face new or heightened risks, including: challenges in quoting for profitable returns on products with leading-edge technologies for which we may not have significant quoting experience; increased warranty and recall risks on new products and leading-edge technologies; increased product liability risks on safety-related products or systems; heightened risk of technological obsolescence of some of our products, processes and/or assets; and difficulties in attracting or retaining employees with critical skills in high-demand areas. Realization of one or more such risks could have a material adverse effect on our profitability, financial condition or operations.
- We may sell some product lines and/or downsize, close or sell some of our operating divisions. By taking such actions, we may incur restructuring, downsizing and/or other significant non-recurring costs. These costs may be higher in some countries than others and could have a material adverse effect on our profitability.
- We depend on the outsourcing of components, modules and assemblies, as well as complete vehicles, by OEMs. The extent of OEM outsourcing is influenced by a number of factors, including: relative cost, quality and timeliness of production by suppliers as compared to OEMs; OEM capacity utilization; OEMs' perceptions regarding the strategic importance of certain components/modules to them; labour relations among OEMs, their employees and unions; and other considerations. A reduction in outsourcing by OEMs, or the loss of any material production or assembly programs combined with the failure to secure alternative programs with sufficient volumes and margins, could have a material adverse effect on our profitability.
- Some of our manufacturing facilities are unionized, as are many manufacturing facilities of our customers and suppliers. Unionized facilities are subject to the risk of labour disruptions from time to time, including as a result of restructuring actions taken by us, our customers and other suppliers. We cannot predict whether or when any labour disruption may arise, or how long such a disruption could last. A significant labour disruption could lead to a lengthy shutdown of our or our customers' and/or our suppliers' production lines, which could have a material adverse effect on our operations and profitability.
- A disruption in the supply of components to us from our suppliers could cause the temporary shut-down of our or our customers' production lines. Any prolonged supply disruption, including due to the inability to re-source or in-source production, could have a material adverse effect on our profitability.

- Our business is generally not seasonal. However, our sales and profits are closely related to our automotive customers' vehicle production schedules. Our largest North American customers typically halt production for approximately two weeks in July and one week in December. In addition, many of our customers in Europe typically shut down vehicle production during portions of August and one week in December. These scheduled shutdowns of our customers' production facilities could cause our sales and profitability to fluctuate when comparing fiscal quarters in any given year.
- Contracts from our customers consist of blanket purchase orders which generally provide for the supply of components for a customer's annual requirements for a particular vehicle, instead of a specific quantity of products. These blanket purchase orders can be terminated by a customer at any time and, if terminated, could result in our incurring various pre-production, engineering and other costs which we may not recover from our customer and which could have an adverse effect on our profitability.
- Prices for certain key raw materials and commodities used in our parts, including steel and resin, can be volatile. To the extent we are unable to offset commodity price increases by passing such increases to our customers, by engineering products with reduced commodity content, through hedging strategies, or otherwise, such additional commodity costs could have an adverse effect on our profitability. Some of our manufacturing facilities generate a significant amount of scrap steel and recover some of the value through scrap steel sales. Scrap steel prices can also be volatile. Declines in scrap steel prices from time to time could have an adverse effect on our profitability.
- Our manufacturing facilities are subject to risks associated with natural disasters or other catastrophic event, including fires, floods, hurricanes and earthquakes. The occurrence of any of these disasters or catastrophic event could cause the total or partial destruction of our or our sub-supplier's manufacturing facility, thus preventing us from supplying products to our customers and disrupting production at their facilities for an indeterminate period of time. The inability to promptly resume the supply of products following a natural disaster or catastrophic event at a manufacturing facility could have a material adverse effect on our operations and profitability.
- The reliability and security of our information technology (IT) systems is important to our business and operations. Although we have established and continue to enhance security controls intended to protect our IT systems and infrastructure, there is no guarantee that such security measures will be effective in preventing unauthorized physical access or cyber-attacks. A significant breach of our IT systems could: cause disruptions in our manufacturing operations; lead to the loss, destruction or inappropriate use of sensitive data; or result in theft of our, our customers' or our suppliers' intellectual property or confidential information. If any of the foregoing events occurs, we may be subject to a number of consequences, including reputational damage, which could have a material adverse effect on our operations.
- Some of our current and former employees in Canada, the United States and Germany participate in defined benefit pension plans. Although such plans in North America have been closed to new participants, existing participants in Canada continue to accrue benefits. Our defined benefit pension plans in Germany are not funded and plans in Canada and the United States may not be fully funded. Our pension funding obligations in North America could increase significantly due to a reduction in plan funding status caused by a variety of factors, including: weak performance of capital markets; declining interest rates; failure to achieve sufficient investment returns; investment risks inherent in the investment portfolios of the plans; and other factors. A significant increase in our pension funding obligations could have an adverse effect on our profitability and financial condition.
- From time to time, we may become involved in regulatory proceedings, or become liable for legal, contractual and other claims by various parties, including customers, suppliers, former employees, class action plaintiffs and others. Depending on the nature or duration of any potential proceedings or claims, we may incur substantial costs and expenses and may be required to devote significant management time and resources to the matters. On an ongoing basis, we attempt to assess the likelihood of any adverse judgments or outcomes to these proceedings or claims, although it is difficult to predict final outcomes with any degree of certainty. Except as disclosed from time to time in our consolidated financial statements and/or our Management's Discussion & Analysis, we do not believe that any of the proceedings or claims to which we are party will have a material adverse effect on our profitability; however, we cannot provide any assurance to this effect.
- We have incurred losses in some countries which we may not be able to fully or partially offset against income we have earned in those countries. In some cases, we may not be able to utilize these losses at all if we cannot generate profits in those countries and/or if we have ceased conducting business in those countries altogether. Our inability to utilize tax losses could materially adversely affect our profitability. At any given time, we may face other tax exposures arising out of changes in tax or transfer pricing laws, tax reassessments or otherwise. To the extent we cannot implement measures to offset these exposures, they may have a material adverse effect on our profitability.
- We have in the past recorded significant impairment charges related to goodwill and long-lived assets and may do so again in the future. The early termination, loss, renegotiation of the terms of, or delay in the implementation of, any significant production contract could be indicators of impairment, as may the technological obsolescence of any of our products or production assets. In addition, to the extent that forward-looking assumptions regarding: the impact of turnaround plans on underperforming operations; new business opportunities; program price and cost assumptions on current and future business; the timing and success of new program launches; and forecast production volumes; are not met, any resulting impairment loss could have a material adverse effect on our profitability.

- We believe we will have sufficient financial resources available to successfully execute our business plan, even in the event of another global recession similar to that of 2008-2009. However, as a result of the reduction of our excess cash in connection with our balance sheet strategy, we may have less financial flexibility than we have had in the last few years. The occurrence of an economic shock not contemplated in our business plan, a rapid deterioration of economic conditions or a more prolonged recession than that experienced in 2008-2009 could result in the depletion of our cash resources, which could have a material adverse effect on our operations and financial condition.
- In recent years, we have invested significant amounts of money in our business through capital expenditures to support new facilities, expansion of existing facilities, purchases of production equipment and acquisitions. Returns achieved on such investments in the past are not necessarily indicative of the returns we may achieve on future investments and our inability to achieve returns on future investments which equal or exceed returns on past investments could have a material adverse effect on our level of profitability.
- Trading prices of our Common Shares cannot be predicted and may fluctuate significantly due to a variety of factors, many of which are outside our control, including: general economic and stock market conditions; variations in our operating results and financial condition; differences between our actual operating and financial results and those expected by investors and stock analysts; changes in recommendations made by stock analysts, whether due to factors relating to us, our customers, the automotive industry or otherwise; significant news or events relating to our primary customers, including the release of vehicle production and sales data; investor and stock analyst perceptions about the prospects for our or our primary customers' respective businesses or the automotive industry; and other factors.

RESULTS OF OPERATIONS

Average Foreign Exchange

	For the three months ended December 31,			For the year ended December 31,		
	2016	2015	Change	2016	2015	Change
1 Canadian dollar equals U.S. dollars	0.749	0.749	-	0.755	0.784	- 4%
1 euro equals U.S. dollars	1.080	1.094	- 1%	1.107	1.111	-
1 British pound equals U.S. dollars	1.241	1.516	- 18%	1.355	1.529	- 11%
1 Chinese renminbi equals U.S. dollars	0.146	0.156	- 6%	0.151	0.159	- 5%
1 Brazilian real equals U.S. dollars	0.304	0.260	+ 17%	0.288	0.305	- 6%

The preceding table reflects the average foreign exchange rates between the most common currencies in which we conduct business and our U.S. dollar reporting currency. The changes in these foreign exchange rates for the three months and year ended December 31, 2016 impacted the reported U.S. dollar amounts of our sales, expenses and income.

The results of operations whose functional currency is not the U.S. dollar are translated into U.S. dollars using the average exchange rates in the table above for the relevant period. Throughout this MD&A, reference is made to the impact of translation of foreign operations on reported U.S. dollar amounts where relevant.

Our results can also be affected by the impact of movements in exchange rates on foreign currency transactions (such as raw material purchases or sales denominated in foreign currencies). However, as a result of hedging programs employed by us, foreign currency transactions in the current period have not been fully impacted by movements in exchange rates. We record foreign currency transactions at the hedged rate where applicable.

Finally, foreign exchange gains and losses on revaluation and/or settlement of monetary items denominated in a currency other than an operation's functional currency impact reported results. These gains and losses are recorded in selling, general and administrative expense.

RESULTS OF OPERATIONS - FOR THE YEAR ENDED DECEMBER 31, 2016

Sales

	2016	2015	Change
Vehicle Production Volumes (millions of units)			
North America	17,817	17,477	+ 2%
Europe	21,434	20,954	+ 2%
Sales			
External Production			
North America	\$ 19,381	\$ 17,759	+ 9%
Europe	9,140	7,252	+ 26%
Asia	2,217	1,612	+ 38%
Rest of World	439	454	- 3%
Complete Vehicle Assembly	2,190	2,357	- 7%
Tooling, Engineering and Other	3,078	2,700	+ 14%
Total Sales	\$ 36,445	\$ 32,134	+ 13%

External Production Sales - North America

External production sales in North America increased 9% or \$1.62 billion to \$19.38 billion compared to \$17.76 billion for 2015, primarily as a result of:

- the launch of new programs during or subsequent to 2015, including the:
 - Chrysler Pacifica;
 - Ford F-Series Superduty;
 - Ford Edge and Lincoln MKX;
 - Chevrolet Malibu;
 - Cadillac XT5; and
 - Lincoln Continental; and
- the acquisition of GETRAG during the first quarter of 2016, which positively impacted production sales by \$593 million.

These factors were partially offset by:

- programs that ended production during or subsequent to 2015;
- a \$225 million decrease in reported U.S. dollar sales as a result of the weakening of foreign currencies against the U.S. dollar, including the Canadian dollar;
- the contribution of two manufacturing facilities into an equity-accounted joint venture during the third quarter of 2015, which negatively impacted production sales by \$67 million;
- lower production volumes on certain existing programs; and
- net customer price concessions subsequent to 2015.

External Production Sales - Europe

External production sales in Europe increased 26% or \$1.89 billion to \$9.14 billion compared to \$7.25 billion for 2015, primarily as a result of:

- acquisitions during or subsequent to 2015, which positively impacted production sales by \$1.42 billion, including GETRAG which positively impacted production sales by \$1.09 billion; and
- the launch of new programs during or subsequent to 2015, including the:
 - Audi A4;
 - Audi A3 and A3 Sportback;
 - Skoda Superb;
 - Mercedes-Benz E-Class; and
 - BMW X1.

These factors were partially offset by:

- a \$146 million decrease in reported U.S. dollar sales as a result of the weakening of foreign currencies against the U.S. dollar, including the British pound, Turkish lira, Russian ruble and euro;
- lower production volumes on the MINI Countryman and Paceman, as well as lower production content on the next generation of these programs which launched during the fourth quarter of 2016;
- lower production volumes on certain existing programs; and
- net customer price concessions subsequent to 2015.

External Production Sales - Asia

External production sales in Asia increased 38% or \$605 million to \$2.22 billion compared to \$1.61 billion for 2015, primarily as a result of:

- the launch of new programs during or subsequent to 2015, primarily in China; and
- acquisitions during or subsequent to 2015, including the partnership agreement in China ("the Xingqiaorui Partnership") with Chongqing Xingqiaorui and the acquisition of GETRAG, which positively impacted production sales by \$302 million.

These factors were partially offset by:

- a \$119 million decrease in reported U.S. dollar sales as a result of the weakening of foreign currencies against the U.S. dollar, including the Chinese renminbi; and
- net customer price concessions subsequent to 2015.

External Production Sales - Rest of World

External production sales in Rest of World decreased 3% or \$15 million to \$439 million for 2016 compared to \$454 million for 2015, primarily as a result of:

- a \$67 million decrease in reported U.S. dollar sales as a result of the weakening of foreign currencies against the U.S. dollar, including the Argentine peso and Brazilian real, each against the U.S. dollar; and
- lower production volumes on certain existing programs.

These factors were partially offset by:

- net customer price increases subsequent to 2015; and
- the launch of new programs during or subsequent to 2015, primarily in Brazil.

Complete Vehicle Assembly Sales

	2016	2015	Change
Complete Vehicle Assembly Sales	\$ 2,190	\$ 2,357	- 7%
Complete Vehicle Assembly Volumes (Units)	75,049	103,904	- 28%

Complete vehicle assembly sales decreased 7% or \$167 million to \$2.19 billion for 2016 compared to \$2.36 billion for 2015 and assembly volumes decreased 28% or 28,855 units.

The decrease in complete vehicle assembly sales is primarily as a result of:

- lower assembly volumes on the MINI Countryman and Paceman during 2016 which ended production during the fourth quarter of 2016; and
- the end of production of the Peugeot RCZ at our Magna Steyr facility during the third quarter of 2015.

These factors were partially offset by an increase in assembly volumes for the Mercedes-Benz G-Class which has a higher average selling price per vehicle compared to the MINI programs.

Tooling, Engineering and Other Sales

Tooling, engineering and other sales increased 14% or \$378 million to \$3.08 billion for 2016 compared to \$2.70 billion for 2015.

In 2016, the major programs for which we recorded tooling, engineering and other sales were the:

- Chrysler Pacifica;
- Chevrolet Cruze;
- Chevrolet Equinox and GMC Terrain;
- GMC Acadia, Buick Enclave and Chevrolet Traverse;
- BMW 5-Series;
- Mercedes-Benz E-Class;
- Chevrolet Malibu;
- Chevrolet Silverado and GMC Sierra; and
- Jeep Renegade.

In 2015, the major programs for which we recorded tooling, engineering and other sales were the:

- Chevrolet Cruze;
- GMC Acadia, Buick Enclave and Chevrolet Traverse;
- Ford F-Series and F-Series Super Duty;
- Audi A4;
- MINI Countryman;
- Chevrolet Equinox and GMC Terrain;
- Ford Edge;
- Chrysler Pacifica and Dodge Caravan;
- BMW 2-Series; and
- Mercedes-Benz M-Class.

Acquisitions during or subsequent to 2015, including GETRAG, increased our reported tooling, engineering and other sales, while the weakening of certain foreign currencies against the U.S. dollar, including the Canadian dollar, Chinese renminbi, British pound and euro had an unfavourable impact of \$45 million on our reported tooling, engineering and other sales.

Cost of Goods Sold and Gross Margin

	2016	2015
Sales	\$ 36,445	\$ 32,134
Cost of goods sold		
Material	22,831	20,270
Direct labour	2,452	2,115
Overhead	5,840	5,174
	31,123	27,559
Gross margin	\$ 5,322	\$ 4,575
Gross margin as a percentage of sales	14.6%	14.2%

Cost of goods sold increased \$3.56 billion to \$31.12 billion for 2016 compared to \$27.56 billion for 2015 primarily as a result of:

- acquisitions subsequent to 2015;
- higher material, overhead and labour costs associated with the increase in sales;
- operational inefficiencies at certain facilities;
- higher warranty costs of \$75 million;
- higher pre-operating costs incurred at new facilities;
- higher launch costs;
- a higher amount of employee profit sharing;
- lower recoveries associated with scrap steel; and
- insurance recoveries received during the first quarter of 2015, related to a fire at a body and chassis facility.

These factors were partially offset by:

- a net decrease in reported U.S. dollar cost of goods sold primarily due to the weakening of the Canadian dollar; Chinese renminbi, British pound and Argentine peso each against the U.S. dollar;
- productivity and efficiency improvements at certain facilities;
- net divestitures during or subsequent to 2015; and
- decreased commodity costs.

Gross margin increased \$747 million to \$5.32 billion for 2016 compared to \$4.58 billion for 2015 and gross margin as a percentage of sales increased to 14.6% for 2016 compared to 14.2% for 2015. The increase in gross margin as a percentage of sales was primarily due to:

- productivity and efficiency improvements at certain facilities;
- a decrease in the proportion of complete vehicle assembly sales relative to total sales, which have a higher material content than our consolidated average; and
- decreased commodity costs.

These factors were partially offset by:

- operational inefficiencies at certain facilities, including one body and chassis operation in North America;
- higher warranty costs;
- the acquisition of GETRAG subsequent to 2015; and
- higher pre-operating costs incurred at new facilities.

Depreciation and Amortization

Depreciation and amortization costs increased \$254 million to \$1.06 billion for 2016 compared to \$802 million for 2015. The higher depreciation and amortization was primarily as a result of:

- acquisitions during or subsequent to 2015, including the acquisition of GETRAG; the Xingqiaorui Partnership; and the acquisition of Stadco Automotive Ltd. ("Stadco");
- increased capital deployed at existing facilities; and
- increased capital deployed at new facilities.

These factors were partially offset by a decrease in reported U.S. dollar depreciation and amortization as a result of the weakening of the Canadian dollar, Chinese renminbi, British pound and euro, each against the U.S. dollar.

Selling, General and Administrative ("SG&A")

SG&A expense as a percentage of sales was 4.4% for 2016 compared to 4.5% for 2015. SG&A expense increased \$153 million to \$1.60 billion for 2016 compared to \$1.45 billion for 2015 primarily as a result of:

- acquisitions during or subsequent to 2015;
- higher labour and benefit costs;
- increased costs incurred at new facilities;
- higher incentive and executive compensation;
- higher foreign exchange losses combined with lower foreign exchange gains;
- higher costs to support our global compliance programs; and
- a higher amount of employee profit sharing.

These factors were partially offset by:

- the weakening of the Canadian dollar, Chinese renminbi, Mexican peso and Argentine peso, each against the U.S. dollar;
- an insurance recovery, net of costs incurred, related to a fire in the second quarter of 2016 at a body and chassis facility in Europe;
- a favourable intellectual property infringement settlement in relation to our electronics business;
- divestitures during or subsequent to 2015;
- lower consulting costs; and
- a \$5 million net increase in valuation gains in respect of asset-backed commercial paper ("ABCP").

Interest Expense, net

During 2016, we recorded net interest expense of \$88 million compared to \$44 million for 2015. The \$44 million increase is primarily as a result of:

- interest expense incurred on the Senior Notes; and
- lower interest income earned due to lower average cash balances during 2016 compared to 2015.

Equity Income

Equity income increased \$29 million to \$233 million for 2016 compared to \$204 million for 2015 primarily as a result of the acquisition of GETRAG in the first quarter of 2016.

Other Expense (Income), net

During the three months and years ended December 31, 2016 and 2015, we recorded other expense (income), net ("Other Income" or "Other Expense") items as follows:

	2016			2015		
	Operating Income	Net Income Attributable to Magna	Diluted Earnings per Share	Operating Income	Net Income Attributable to Magna	Diluted Earnings per Share
Fourth Quarter						
Restructuring ⁽¹⁾	\$ 17	\$ 17	\$ 0.05	\$ 15	\$ 15	\$ 0.03
Pension settlement ⁽²⁾	13	9	0.02	–	–	–
	30	26	0.07	15	15	0.03
Third Quarter						
Gain on disposal ⁽³⁾	–	–	–	(136)	(80)	(0.19)
Restructuring ⁽¹⁾	–	–	–	12	12	0.03
	–	–	–	(124)	(68)	(0.16)
Second Quarter						
Gain on disposal ⁽³⁾	–	–	–	(57)	(42)	(0.10)
Full year other expense (income), net	\$ 30	\$ 26	\$ 0.07	\$ (166)	\$ (95)	\$ (0.23)

(1) Restructuring

[a] For the year ended December 31, 2016

During 2016, we recorded net restructuring charges of \$17 million (\$17 million after tax) in Germany at a powertrain systems facility.

[b] For the year ended December 31, 2015

During 2015, we recorded net restructuring charges of \$27 million (\$27 million after tax) primarily in Germany at our exterior systems and roof systems operations.

(2) Pension settlement

During the fourth quarter of 2016, we offered a limited lump-sum payout to certain terminated vested plan participants of our U.S. defined benefit pension plans. As a result of the partial settlement, we recognized a \$13 million (\$9 million after tax) non-cash settlement charge.

(3) Gains on disposal

During the third quarter of 2015, we contributed two manufacturing facilities and received a 49% interest in a newly formed joint venture and cash proceeds of \$118 million. Total consideration was valued at \$160 million, and as a result we recognized a gain of \$136 million (\$80 million after tax).

During the second quarter of 2015, we sold our battery pack business to Samsung SDI for gross proceeds of \$120 million, resulting in a gain of \$57 million (\$42 million after tax).

Income from Continuing Operations before Income Taxes

Income from continuing operations before income taxes increased \$129 million to \$2.78 billion for 2016 compared to \$2.65 billion for 2015. The increase in income from continuing operations before income taxes is the result of:

- margins earned on higher production sales;
- acquisitions during or subsequent to 2015;
- productivity and efficiency improvements at certain facilities;
- decreased commodity costs;
- an insurance recovery, net of costs incurred, related to a fire in the second quarter of 2016 at a body and chassis facility in Europe;
- a favourable intellectual property infringement settlement in relation to our electronics business;
- divestitures during or subsequent to 2015;
- lower consulting costs; and
- a \$5 million net increase in valuation gains in respect of ABCP.

These factors were partially offset by:

- lower other expense (income), net of \$196 million, as discussed above;
- operational inefficiencies at certain facilities, including one body and chassis operation in North America;
- higher warranty costs of \$75 million;
- the \$44 million increase in interest expense, net, as discussed above;
- the negative impact of foreign exchange translation from the weakening of foreign currencies, including the Canadian dollar, Chinese renminbi, British pound; partially offset by the strengthening of the Mexican peso; Brazilian real and Argentine peso, each against the U.S. dollar;
- higher incentive and executive compensation;
- higher pre-operating costs incurred at new facilities;
- higher foreign exchange losses combined with lower foreign exchange gains;
- higher costs to support our global compliance programs;
- higher launch costs;
- a higher amount of employee profit sharing; and
- lower recoveries associated with scrap steel.

Income Taxes

	2016		2015	
	\$	%	\$	%
Income taxes as reported	\$ 706	25.4	\$ 711	26.8
Tax effect on Other Expense (Income), net	4	(0.1)	(71)	(1.0)
	\$ 710	25.3	\$ 640	25.8

Excluding Other Expense (Income), net, after tax, the effective income tax rate decreased to 25.3% for 2016 compared to 25.8% for 2015 primarily as a result of:

- lower non-creditable withholding tax;
- a reduction in losses not benefitted in Asia, South America and Europe;
- valuation allowance releases in Europe, Asia and North America; and
- an increase in equity income.

These factors were partially offset by:

- a benefit recorded in 2015 on the write-off of historical tax basis in one of our South American subsidiaries; and
- a change in our reserves for uncertain tax positions.

(Income) Loss from Continuing Operations Attributable to Non-Controlling Interests

Income from continuing operations attributable to non-controlling interests increased to \$43 million for 2016 compared to a loss from continuing operations attributable to non-controlling interests of \$6 million for 2015, primarily due to acquisitions during or subsequent to 2015, including GETRAG and the Xingqiaorui Partnership.

Net Income Attributable to Magna International Inc.

Net income attributable to Magna International Inc. of \$2.03 billion for 2016 increased \$18 million compared to \$2.01 billion in 2015, primarily as a result of the increase in net income from continuing operations before income taxes and lower income taxes, partially offset by a decrease in the income from discontinued operations, net of tax and an increase in the (income) loss from continuing operations attributable to non-controlling interests, each as discussed above.

Earnings per Share

	2016	2015	Change	
Basic earnings per Common Share				
Continuing operations	\$ 5.19	\$ 4.78	+	9%
Attributable to Magna International Inc.	\$ 5.19	\$ 4.94	+	5%
Diluted earnings per Common Share				
Continuing operations	\$ 5.16	\$ 4.72	+	9%
Attributable to Magna International Inc.	\$ 5.16	\$ 4.88	+	6%
Weighted average number of Common Shares outstanding (millions)				
Basic	391.0	407.5	-	4%
Diluted	393.2	412.7	-	5%

Diluted earnings per share from continuing operations increased \$0.44 to \$5.16 compared to \$4.72 for 2015. Other Expense (Income), net, after tax, negatively impacted diluted earnings per share from continuing operations by \$0.07 in 2016 and positively impacted diluted earnings per share from continuing operations by \$0.23 in 2015 as discussed in the "Other Expense (Income), net" section. Excluding these impacts, diluted earnings per share from continuing operations increased \$0.74, as a result of the increase in net income attributable to Magna International Inc. from continuing operations and a decrease in the weighted average number of diluted shares outstanding during 2016.

The decrease in the weighted average number of diluted shares outstanding was primarily due to the purchase and cancellation of Common Shares, during or subsequent to 2015, pursuant to our normal course issuer bids.

SEGMENT ANALYSIS

Given the differences between the regions in which we operate, our operations are segmented on a geographic basis. Consistent with the above, our internal financial reporting separately segments key internal operating performance measures between North America, Europe, Asia and Rest of World for purposes of presentation to the chief operating decision maker to assist in the assessment of operating performance, the allocation of resources, and our long-term strategic direction and future global growth.

Our chief operating decision maker uses Adjusted EBIT as the measure of segment profit or loss, since we believe Adjusted EBIT is the most appropriate measure of operational profitability or loss for our reporting segments.

The following table reconciles net income from continuing operations to Adjusted EBIT:

	2016	2015
Net income from continuing operations	\$ 2,074	\$ 1,940
Add (deduct):		
Interest expense, net	88	44
Other expense (income), net	30	(166)
Income taxes	706	711
Adjusted EBIT	\$ 2,898	\$ 2,529

	Total Sales			Adjusted EBIT		
	2016	2015	Change	2016	2015	Change
North America	\$ 20,744	\$ 19,015	\$ 1,729	\$ 2,061	\$ 1,934	\$ 127
Europe	13,080	11,123	1,957	543	451	92
Asia	2,674	1,981	693	266	149	117
Rest of World	465	461	4	(17)	(25)	8
Corporate and Other	(518)	(446)	(72)	45	20	25
Total reportable segments	\$ 36,445	\$ 32,134	\$ 4,311	\$ 2,898	\$ 2,529	\$ 369

North America

Adjusted EBIT in North America increased \$127 million to \$2.06 billion for 2016 compared to \$1.93 billion for 2015 primarily as a result of:

- margins earned on higher production sales;
- the acquisition of GETRAG during the first quarter of 2016;
- productivity and efficiency improvements at certain facilities;
- decreased commodity costs;
- a favourable intellectual property infringement settlement in relation to our electronics business; and
- lower launch costs.

These factors were partially offset by:

- operational inefficiencies at certain facilities, including one body and chassis operation;
- higher warranty costs of \$33 million;
- a decrease in reported U.S. dollar Adjusted EBIT due to the weakening of the Canadian dollar against the U.S. dollar;
- lower equity income;
- higher affiliation fees paid to Corporate;
- higher incentive compensation;
- lower recoveries associated with scrap steel;
- higher pre-operating costs incurred at new facilities;
- insurance recoveries received during the first quarter of 2015, related to a fire at a body and chassis facility; and
- net customer price concessions subsequent to 2015.

Europe

Adjusted EBIT in Europe increased \$92 million to \$543 million for 2016 compared to \$451 million for 2015 primarily as a result of:

- margins earned on higher production sales;
- acquisitions during or subsequent to 2015;
- productivity and efficiency improvements at certain facilities;
- an insurance recovery, net of costs incurred, related to a fire in the second quarter of 2016 at a body and chassis facility in Europe; and
- decreased commodity costs.

These factors were partially offset by:

- operational inefficiencies at certain facilities;
- higher warranty costs of \$34 million;
- higher launch costs;
- a decrease in reported U.S. dollar Adjusted EBIT due to the weakening of the British pound, Turkish lira and Russian ruble, each against the U.S. dollar;
- higher affiliation fees paid to Corporate;
- higher pre-operating costs incurred at new facilities;
- a higher amount of employee profit sharing;
- higher incentive compensation; and
- net customer price concessions subsequent to 2015.

Asia

Adjusted EBIT in Asia increased \$117 million to \$266 million for 2016 compared to \$149 million for 2015 primarily as a result of:

- margins earned on higher production sales;
- acquisitions during or subsequent to 2015, including the Xingqiaorui Partnership and GETRAG;
- productivity and efficiency improvements at certain facilities;
- decreased commodity costs;
- lower launch costs; and
- higher equity income.

These factors were partially offset by:

- a decrease in reported U.S. dollar Adjusted EBIT due to the weakening of the Chinese renminbi against the U.S. dollar;
- operational inefficiencies at certain facilities;
- higher pre-operating costs incurred at new facilities;
- higher warranty costs of \$8 million; and
- a higher amount of employee profit sharing.

Rest of World

Adjusted EBIT in Rest of World improved \$8 million to a loss of \$17 million for 2016 compared to a loss of \$25 million for 2015 primarily as a result of:

- net customer price increases subsequent to 2015;
- an increase in reported U.S. dollar Adjusted EBIT due to the strengthening of the Brazilian real and Argentine peso, each, against the U.S. dollar;
- productivity and efficiency improvements at certain facilities;
- higher equity income; and
- lower pre-operating costs incurred at new facilities.

These factors were partially offset by:

- decreased margins earned on lower production sales;
- higher incentive compensation.

Corporate and Other

Adjusted EBIT in Corporate and Other increased \$25 million to \$45 million for 2016 compared to \$20 million for 2015 primarily as a result of:

- an increase in affiliation fees earned from our divisions;
- lower consulting costs; and
- a \$5 million net increase in valuation gains in respect of ABCP.

These factors were partially offset by:

- higher costs to support our global compliance programs;
- higher incentive compensation;
- higher net foreign exchange losses; and
- higher labour costs.

FINANCIAL CONDITION, LIQUIDITY AND CAPITAL RESOURCES

Cash Flow from Operations

	2016	2015	Change
Net income from continuing operations	\$ 2,074	\$ 1,940	
Items not involving current cash flows	1,231	736	
	3,305	2,676	\$ 629
Changes in operating assets and liabilities	81	(344)	
Cash provided from operating activities	\$ 3,386	\$ 2,332	\$ 1,054

Cash provided from operating activities before changes in operating assets and liabilities increased \$629 million for 2016 compared to 2015 primarily as a result of:

- an increase in cash received from customers of \$4.28 billion as a result of higher total sales as discussed above;
- a decrease in current income taxes of \$32 million; and
- higher dividends received from equity investments of \$40 million.

These factors were partially offset by:

- higher cash paid for material, labour and overhead of \$2.54 billion, \$695 million and \$401 million, respectively, each primarily associated with the increase in sales and other factors discussed in the Cost of Goods Sold and Gross Margin section above;
- higher SG&A expense of \$54 million as discussed in the Selling, General and Administrative section above; and
- higher net interest expense of \$42 million as discussed in the Interest Expense, net section above.

Changes in operating assets and liabilities increased \$425 million for 2016 compared to 2015 primarily due to the increase in accounts payable due to increased sales and timing of payments.

Capital and Investment Spending

	2016	2015	Change
Fixed asset additions	\$ (1,807)	\$ (1,591)	
Investments and other assets	(478)	(221)	
Fixed assets, investments and other assets additions	(2,285)	(1,812)	
Purchase of subsidiaries	(1,930)	(222)	
Restricted cash deposits	(194)	–	
Proceeds from disposition	138	61	
Sale of Interiors	–	520	
Proceeds on disposal of facilities	–	221	
Cash used in discontinued operations	–	(56)	
Cash used for investment activities	\$ (4,271)	\$ (1,288)	\$ (2,983)

Fixed assets, investments and other assets additions

In 2016, we invested \$1.81 billion in fixed assets. While investments were made to refurbish or replace assets consumed in the normal course of business and for productivity improvements, a large portion of the investment in 2016 was for manufacturing equipment for programs that will be launching subsequent to 2016.

We provided a \$92 million loan to one of our equity-accounted joint ventures, we invested \$357 million in other assets related primarily to fully reimbursable tooling, planning, and engineering costs for programs that launched during 2016 or will be launching subsequent to 2016 and we invested \$29 million in equity-accounted investments.

Restricted cash deposits

In 2016, we had \$194 million invested in short-term restricted cash deposits. These deposits secure \$185 million drawn on a euro credit facility with a bank that includes a netting arrangement that provides for the legal right of set-off.

Proceeds from disposition

In 2016, the \$138 million of proceeds include normal course fixed and other asset disposals.

Sale of Interiors

On August 31, 2015 we sold substantially all of our interiors operations (excluding our seating operations) and received \$520 million of proceeds, net of transaction costs.

Proceeds on disposal of facilities

During 2015, we received \$221 million of proceeds on disposal of facilities related to the:

- sale of our battery pack business to Samsung SDI; and
- formation of a joint venture for the manufacture and sale of roof and other accessories for the Jeep market to original equipment manufacturers as well as aftermarket customers.

Financing

	2016	2015	Change
Issues of debt	\$ 282	\$ 1,608	
Increase in short-term borrowings	386	25	
Repayments of debt	(417)	(99)	
Issue of Common Shares on exercise of stock options	33	35	
Repurchase of Common Shares	(913)	(515)	
Contributions to subsidiaries by non-controlling interests	(1)	41	
Dividends paid to non-controlling interests	(5)	–	
Dividends paid	(385)	(354)	
Cash (used for) provided from financing activities	\$ (1,020)	\$ 741	\$ (1,761)

Issues of debt relates primarily to the issue of Senior Notes during 2015. Senior Notes are senior unsecured obligations and do not include any financial covenants. We may redeem the Senior Notes in whole or in part at any time, at specified redemption prices determined in accordance with the terms of each of the respective indentures governing the Senior Notes. The funds raised through these offerings were used for general corporate purposes, including capital expenditures, as well as the acquisition of GETRAG.

During 2016 we issued \$295 million of U.S. commercial paper [the "U.S. Program"] and we borrowed \$185 million against a euro credit facility. These increases were offset by a reduction in our bank indebtedness.

A portion of the proceeds from the issue of the U.S. Program were used to repay \$169 million on our global credit facility. We also repaid bank debt within our Asia segment that is included in debt repayments.

Repurchases of Common Shares during 2016 includes 22.6 million Common Shares repurchased for aggregate cash consideration of \$913 million.

Cash dividends paid per Common Share were \$1.00 for 2016, for a total of \$385 million.

Financing Resources

	As at December 31, 2016	As at December 31, 2015	Change
Liabilities			
Short-term borrowings	\$ 623	\$ 25	
Long-term debt due within one year	139	211	
Long-term debt	2,394	2,327	
	3,156	2,563	
Non-controlling interests	451	151	
Shareholders' equity	9,768	8,966	
Total capitalization	\$ 13,375	\$ 11,680	\$ 1,695

Total capitalization increased by \$1.70 billion to \$13.38 billion as at December 31, 2016 compared to \$11.68 billion at December 31, 2015, primarily as a result of a \$802 million increase in shareholders' equity, a \$593 million increase in liabilities and a \$300 million increase in non-controlling interest.

The increase in liabilities relates primarily to:

- the issuance of \$295 million of U.S. commercial paper [the "U.S. Program"] during 2016 and the issuance of \$320 million of euro-commercial paper [the "euro-Program"] during 2016. These programs allow us to minimize the amount of cash on hand to run our business by providing funding on a more flexible and cost effective basis compared to drawing on our revolving credit facility;
- higher short-term borrowings are primarily as a result of an increase in non-cash working capital and cash deployed for the repurchase and cancellation of Common Shares under our normal course issuer bid during 2016; and
- higher long-term debt primarily as a result of the acquisition of GETRAG in the first quarter of 2016.

The increase in shareholders' equity was primarily as a result of the \$2.07 billion of net income earned in 2016, partially offset by the \$913 million repurchase and cancellation of 22.6 million Common Shares during 2016 and \$385 million of dividends paid during 2016.

The increase in non-controlling interest was primarily as a result of acquisitions during or subsequent to 2015.

Cash Resources

During 2016, our cash resources decreased by \$1.89 billion to \$974 million as a result of the cash used for investing and financing activities, partially offset by cash provided from operating activities, as discussed above. In addition to our cash resources at December 31, 2016, we had term and operating lines of credit totalling \$2.91 billion of which \$2.10 billion was unused and available.

The Company maintains a revolving credit facility of \$2.75 billion with a maturity date of June 22, 2021. The facility includes a \$200 million Asian tranche, a \$100 million Mexican tranche and a tranche for Canada, U.S. and Europe, which is fully transferable between jurisdictions and can be drawn in U.S. dollars, Canadian dollars or euros.

Maximum Number of Shares Issuable

The following table presents the maximum number of shares that would be outstanding if all of the outstanding options at March 9, 2017 were exercised:

Common Shares	382,269,005
Stock options ⁽ⁱ⁾	9,258,413
	391,527,418

(i) Options to purchase Common Shares are exercisable by the holder in accordance with the vesting provisions and upon payment of the exercise price as may be determined from time to time pursuant to our stock option plans.

Contractual Obligations and Off-Balance Sheet Financing

A purchase obligation is defined as an agreement to purchase goods or services that is enforceable and legally binding on us and that specifies all significant terms, including: fixed or minimum quantities to be purchased; fixed, minimum or variable price provisions; and the approximate timing of the transaction. Consistent with our customer obligations, substantially all of our purchases are made under purchase orders with our suppliers which are requirements based and accordingly do not specify minimum quantities. Other long-term liabilities are defined as long-term liabilities that are recorded on our consolidated balance sheet. Based on this definition, the following table includes only those contracts which include fixed or minimum obligations.

At December 31, 2016, we had contractual obligations requiring annual payments as follows:

	2017	2018- 2019	2020- 2021	Thereafter	Total
Operating leases	\$ 277	\$ 445	\$ 347	\$ 568	\$ 1,655
Long-term debt	139	65	42	2,287	2,533
Unconditional purchase obligations:					
Materials and services	2,758	419	162	5	3,344
Capital	1,096	191	51	14	1,352
Total contractual obligations	\$ 4,270	\$ 1,120	\$ 602	\$ 2,892	\$ 8,884

Our unfunded obligations with respect to employee future benefit plans, which have been actuarially determined, were \$652 million at December 31, 2016. These obligations are as follows:

	Pension Liability	Retirement Liability	Termination and Long Service Arrangements	Total
Projected benefit obligation	\$ 624	\$ 31	\$ 327	\$ 982
Less plan assets	(330)	–	–	(330)
Unfunded amount	\$ 294	\$ 31	\$ 327	\$ 652

Our off-balance sheet financing arrangements are limited to operating lease contracts.

We have facilities that are subject to operating leases. Operating lease payments in 2016 for facilities were \$252 million. Operating lease commitments in 2017 for facilities are expected to be \$228 million. A majority of our existing lease agreements generally provide for periodic rent escalations based either on fixed-rate step increases, or on the basis of a consumer price index adjustment (subject to certain caps).

We also have operating lease commitments for equipment. These leases are generally of shorter duration. Operating lease payments for equipment were \$63 million for 2016, and are expected to be \$49 million in 2017.

Although our consolidated contractual annual lease commitments decline year by year, we expect that existing leases will either be renewed or replaced, or alternatively, we will incur capital expenditures to acquire equivalent capacity.

Foreign Currency Activities

Our North American operations negotiate sales contracts with OEMs for payment in both U.S. and Canadian dollars. Materials and equipment are purchased in various currencies depending upon competitive factors, including relative currency values. Our North American operations use labour and materials which are paid for in both U.S. and Canadian dollars. Our Mexican operations generally use the U.S. dollar as the functional currency.

Our European operations negotiate sales contracts with OEMs for payment principally in euros and British pounds. The European operations' material, equipment and labour are paid for principally in euros and British pounds.

We employ hedging programs, primarily through the use of foreign exchange forward contracts, in an effort to manage our foreign exchange exposure, which arises when manufacturing facilities have committed to the delivery of products for which the selling price has been quoted in foreign currencies. These commitments represent our contractual obligations to deliver products over the duration of the product programs, which can last a number of years. The amount and timing of the forward contracts will be dependent upon a number of factors, including anticipated production delivery schedules and anticipated production costs, which may be paid in the foreign currency. In addition, we enter into foreign exchange contracts to manage foreign exchange exposure with respect to internal funding arrangements. Despite these measures, significant long-term fluctuations in relative currency values, in particular a significant change in the relative values of the U.S. dollar, Canadian dollar, euro or British pound, could have an adverse effect on our profitability and financial condition (as discussed throughout this MD&A).

SIGNIFICANT ACCOUNTING POLICIES AND CRITICAL ACCOUNTING ESTIMATES

Our significant accounting policies are more fully described in Note 1, "Significant Accounting Policies," to the consolidated financial statements included in this Report. The preparation of the audited consolidated financial statements requires management to make estimates and assumptions that affect the reported amounts of assets, liabilities, revenues and expenses and the related disclosure of contingent assets and liabilities, as of the date of the consolidated financial statements. These estimates and assumptions are based on our historical experience, and various other assumptions we believe to be reasonable in the circumstances. Since these estimates and assumptions are subject to an inherent degree of uncertainty, actual results in these areas may differ significantly from our estimates.

We believe the following critical accounting policies and estimates affect the more subjective or complex judgments and estimates used in the preparation of our consolidated financial statements and accompanying notes. Management has discussed the development and selection of the following critical accounting policies with the Audit Committee of the Board of Directors, and the Audit Committee has reviewed our disclosure relating to critical accounting policies in this MD&A.

Acquisitions

We allocate the purchase price of an acquired business to its identifiable assets and liabilities based on estimated fair values. The excess of the purchase price over the amount allocated to the assets and liabilities, if any, is recorded as goodwill. We use all available information to estimate fair values. We typically engage outside appraisal firms to assist in the fair value determination of identifiable intangible assets and any other significant assets or liabilities. We adjust the preliminary purchase price allocation, as necessary, up to one year after the acquisition closing date as we obtain more information regarding asset valuations and liabilities assumed.

Our purchase price allocation methodology contains uncertainties because it requires management to make assumptions and to apply judgment to estimate the fair value of acquired assets and assumed liabilities. Management estimates the fair value of assets and liabilities based upon quoted market prices, the carrying value of the acquired assets and widely accepted valuation techniques, including discounted cash flows and market multiple analyses. Unanticipated events or circumstances may occur which could affect the accuracy of our fair value estimates, including assumptions regarding industry economic factors and business strategies. Accordingly, there can be no assurance that the estimates, assumptions, and values reflected in the valuations will be realized, and actual results could vary.

Impairment of Goodwill and Other Long-lived Assets

We review goodwill at the reporting unit level for impairment annually or more frequently if events or changes in circumstances indicate that goodwill might be impaired. We perform a two-step goodwill impairment test in conjunction with our annual business plan during the fourth quarter of each year. In step one, the fair value of a reporting unit is compared to its carrying value. If the fair value is greater than its carrying amount, goodwill is not considered to be impaired and the second step is not required. However, if the fair value of the reporting unit is less than its carrying amount, the second step must be performed to measure the amount of the impairment loss, if any. The second step requires a reporting unit to compare its implied fair value of goodwill to its carrying amount. If the carrying amount of goodwill exceeds its implied fair value, the reporting unit would recognize an impairment loss for that excess. In January 2017, the FASB issued guidance which will eliminate the second step requiring an impairment charge to be recognized for the amount by which the carrying amount exceeds the reporting unit's fair value. Refer to Note 2. Accounting Standards to the audited consolidated financial statements included in this report for additional details on the effective date and adoption.

In addition to our review of goodwill, we evaluate fixed assets and other long-lived assets for impairment whenever indicators of impairment exist. Indicators of impairment include the bankruptcy of a significant customer or the early termination, loss, renegotiation of the terms of, or delay in the implementation of, any significant production contract. If the sum of the future cash flows expected to result from the asset, undiscounted and without interest charges, is less than the reported value of the asset, an asset impairment would be recognized in the consolidated financial statements. The amount of impairment to be recognized is calculated by subtracting the fair value of the asset from the reported value of the asset.

We believe that accounting estimates related to goodwill and long-lived asset impairment assessments are "critical accounting estimates" because: (i) they are subject to significant measurement uncertainty and are susceptible to change as management is required to make forward-looking assumptions regarding the impact of improvement plans on current operations, in-sourcing and other new business opportunities, program pricing and cost assumptions on current and future business, the timing of new program launches and future forecasted production volumes; and (ii) any resulting impairment loss could have a material impact on our consolidated net income and on the amount of assets reported in our consolidated balance sheet.

Revenue Recognition - Tooling and Engineering Service Contracts

With respect to our contracts with OEMs for particular vehicle programs, we perform multiple revenue-generating activities. The most common arrangement is where, in addition to contracting for the production and sale of parts, we also have a contract with the OEM for engineering services, related tooling, and in some cases subsequent assembly activities. Under these arrangements, we either construct the tools at our in-house tool shops or contract with third party tooling vendors to construct and supply tooling to be used by us in the production of parts for the OEM. On completion of the tooling build, and upon acceptance of the tooling by the OEM, we sell the tooling to the OEM pursuant to a separate tooling purchase order.

Revenues from significant engineering services and tooling contracts that qualify as separate revenue elements are recognized on a percentage of completion basis. The percentage of completion method recognizes revenue and cost of sales over the term of the contract based on estimates of the state of completion, total contract revenue and total contract costs. Contract costs are estimated at the time of signing the contract and are reviewed at each reporting date. Adjustments to the original estimates of total contract costs are often required as work progresses under the contract and as experience is gained, even though the scope of the work under the contract may not change.

Tooling and engineering contract prices are generally fixed; however, price changes, change orders and program cancellations may affect the ultimate amount of revenue recorded with respect to a contract. When the current estimates of total contract revenue and total contract costs indicate a loss, a provision for the entire loss on the contract is made. Factors that are considered in arriving at the forecasted loss on a contract include, amongst others, cost over-runs, non-reimbursable costs, change orders and potential price changes.

Revenues and cost of sales from tooling and engineering services contracts are presented on a gross basis in the consolidated statements of income when we are acting as principal and are subject to significant risks and rewards of the business. Otherwise, components of revenue and related costs are presented on a net basis. To date, substantially all engineering services and tooling contracts have been recorded on a gross basis.

Warranty

We record product warranty liabilities based on individual customer agreements. Under most customer agreements, we only account for existing or probable claims on product default issues when amounts related to such issues are probable and reasonably estimable. Under certain complete vehicle engineering and assembly contracts, we record an estimate of future warranty-related costs based on the terms of the specific customer agreements and the specific customers' warranty experience.

Product liability provisions are established based on our best estimate of the amounts necessary to settle existing claims on product default issues. Recall costs are costs incurred when government regulators and/or our customers decide to recall a product due to a known or suspected performance issue, and we are required to participate either voluntarily or involuntarily. Costs typically include the cost of the product being replaced, the customer's cost of the recall and labour to remove and replace the defective part. When a decision to recall a product has been made or is probable, our estimated cost of the recall is recorded as a charge to income in that period. In making this estimate, judgment is required as to the number of units that may be returned as a result of the recall, the total cost of the recall campaign, the ultimate negotiated sharing of the cost between us, the customer and, in some cases a supplier.

We monitor our warranty activity on an ongoing basis and adjust our reserve estimates when it is probable that future warranty costs will be different than those estimates.

Income Taxes

We are subject to income taxes in Canada and other non-Canadian jurisdictions. Significant judgement and estimates are required in determining our provision for income taxes, deferred tax assets and liabilities, and liabilities for unrecognized tax benefits.

The determination of our tax liabilities involves dealing with uncertainties in the application of complex tax laws. We recognize tax benefits from uncertain tax positions only if it is more likely than not that the tax position will be sustained on examination by the taxing authorities, based on the technical merits of the position. The tax benefits recognized in the financial statements from such positions are then measured based on the largest benefit that has a greater than 50% likelihood of being realized upon ultimate settlement.

At December 31, 2016, we had gross unrecognized tax benefits of \$220 million excluding interest and penalties, of which \$201 million, if recognized, would affect our effective tax rate. The gross unrecognized tax benefits differ from the amount that would affect our effective tax rate due primarily to the impact of the valuation allowance on deferred tax assets.

Deferred tax assets and liabilities are recognized for the estimated future tax effects attributable to temporary differences between financial statement carrying value of existing assets and liabilities and their respective tax bases and tax loss and credit carryforwards. Deferred tax assets and liabilities are measured using the enacted tax rates and laws that will be in effect when the differences are expected to reverse.

Accounting standards require that we assess whether valuation allowances should be established or maintained against our deferred income tax assets, based on consideration of all available evidence, using a "more-likely-than-not" standard. The factors used to assess the likelihood of realization are: history of losses, forecasts of future pre-tax income and tax planning strategies that could be implemented to realize the deferred tax assets. On a quarterly basis, we evaluate the realizability of deferred tax assets by assessing our valuation allowances and by adjusting the amount of such allowances as necessary. We use tax planning strategies to realize deferred tax assets to avoid the potential loss of benefits.

At December 31, 2016, we had recorded deferred tax assets (net of related valuation allowances) in respect of loss carryforwards and other deductible temporary differences of \$100 million and \$253 million, respectively. The deferred tax assets in respect of loss carryforwards relate primarily to operations in Germany, the United Kingdom, Canada, Mexico and Italy. We had domestic and foreign operating loss carryforwards of \$2.29 billion and tax credit carryforwards of \$22 million, which relate primarily to operations in Germany, Austria, the United States, Brazil, the United Kingdom, Spain and China. Approximately \$1.65 billion of the operating losses can be carried forward indefinitely. The remaining operating losses and tax credit carryforwards expire between 2017 and 2036.

Employee Future Benefit Plans

The determination of the obligation and expense for defined benefit pension, termination and long service arrangements and other post-retirement benefits, such as retiree healthcare and medical benefits, is dependent on the selection of certain assumptions used by actuaries in calculating such amounts. Those assumptions include, among others, the discount rate, expected long-term rate of return on plan assets and rates of increase in compensation costs. Actual results that differ from the assumptions used are accumulated and amortized over future periods and therefore impact the recognized expense in future periods. Significant changes in assumptions or significant plan amendments could materially affect our future employee benefit obligations and future expense.

At December 31, 2016, we had past service costs and actuarial experience losses of \$215 million included in accumulated other comprehensive income that will be amortized to future employee benefit expense over the expected average remaining service life of employees or over the expected average life expectancy of retired employees, depending on the status of the plan.

FUTURE CHANGES IN ACCOUNTING POLICIES

Refer to Note 2. Accounting Standards to the audited consolidated financial statements included in this report for the impact of recently issued accounting pronouncements.

COMMITMENTS AND CONTINGENCIES

From time to time, we may be contingently liable for litigation, legal and/or regulatory actions and proceedings and other claims.

Refer to note 16 of our unaudited interim consolidated financial statements for the three months and year ended December 31, 2016, which describes these claims.

For a discussion of risk factors relating to legal and other claims/actions against us, refer to "Item 3. Description of the Business – Risk Factors" in our Annual Information Form and Annual Report on Form 40-F, each in respect of the year ended December 31, 2015.

CONTROLS AND PROCEDURES

Disclosure Controls and Procedures

Disclosure controls and procedures (as defined in Rules 13a-15(e) and 15d-15(e) under the Securities Exchange Act of 1934, as amended (the "Exchange Act") are designed to ensure that material information required to be disclosed in reports filed or submitted under the Exchange Act is recorded, processed, summarized and reported on a timely basis, and that such information is accumulated and communicated to senior management, including the Company's Chief Executive Officer and Chief Financial Officer, as appropriate, to enable them to make timely decisions regarding required disclosure of such information. We have conducted an evaluation of our disclosure controls and procedures as of December 31, 2016 under the supervision, and with the participation of, our Chief Executive Officer and our Chief Financial Officer. Based on this evaluation, our Chief Executive Officer and our Chief Financial Officer have concluded that our disclosure controls and procedures (as this term is defined in the rules adopted by Canadian securities regulatory authorities and the United States Securities and Exchange Commission ("SEC")) are effective as of December 31, 2016.

Management's Annual Report on Internal Control over Financial Reporting

Internal control over financial reporting is a process designed to provide reasonable, but not absolute, assurance regarding the reliability of financial reporting and preparation of financial statements for external purposes in accordance with accounting principles generally accepted in the United States. Our management is responsible for establishing and maintaining adequate internal control over financial reporting. Due to its inherent limitations, internal control over financial reporting may not prevent or detect misstatements on a timely basis. Additionally, projections of any evaluation of the effectiveness of internal control over financial reporting to future periods are subject to the risk that the controls may become inadequate because of changes in conditions, or that the degree of compliance with the policies or procedures may deteriorate. Our management used the Committee of Sponsoring Organizations of the Treadway Commission (COSO) Internal Control-Integrated Framework (2013) to evaluate the effectiveness of internal control over financial reporting. On January 4, 2016, we completed the acquisition of GETRAG. As permitted by securities rules and regulations, we have excluded GETRAG from our evaluation of internal control over financial reporting as of December 31, 2016. The excluded GETRAG assets constituted 7% of our total assets as of December 31, 2016. Overall, GETRAG constituted 6% of our sales and 2% of our net income for the year ended December 31, 2016. Based on this evaluation, our Chief Executive Officer and our Chief Financial Officer have assessed the effectiveness of our internal control over financial reporting and concluded that, as at December 31, 2016, such internal control over financial reporting is effective. The Company's internal control over financial reporting as of December 31, 2016 has been audited by Deloitte LLP, Independent Registered Public Accounting Firm who also audited the Company's consolidated financial statements for the year ended December 31, 2016. Deloitte LLP expressed an unqualified opinion on the effectiveness of the Company's internal control over financial reporting. This report precedes our audited consolidated financial statements for the year ended December 31, 2016.

Changes in Internal Controls over Financial Reporting

Other than the addition of GETRAG's operations to our internal control over financial reporting, there have been no changes in our internal controls over financial reporting that occurred during 2016 that have materially affected, or are reasonably likely to materially affect, our internal control over financial reporting. The Company is currently integrating GETRAG into its operations, compliance programs and internal control process. As permitted by the securities rules and regulations, the Company has excluded GETRAG from management's evaluation of internal control over financial reporting as of December 31, 2016.

RESULTS OF OPERATIONS – FOR THE THREE MONTHS ENDED DECEMBER 31, 2016

The discussion of our results of operations for the three months ended December 31, 2016 contained in the MD&A attached to our press release dated February 24, 2017, as filed via the Canadian Securities Administrators' System for Electronic Document Analysis and Retrieval (SEDAR) (www.sedar.com), is incorporated by reference herein.

SELECTED QUARTERLY CONSOLIDATED FINANCIAL DATA

The following selected consolidated financial data has been prepared in accordance with U.S. GAAP.

	For the three month periods ended			
	Mar 31, 2016	Jun 30, 2016	Sep 30, 2016	Dec 31, 2016
Sales	\$ 8,900	\$ 9,443	\$ 8,849	\$ 9,253
Net income	\$ 503	\$ 561	\$ 514	\$ 496
Basic earnings per Common Share				
Continuing operations	\$ 1.23	\$ 1.42	\$ 1.30	\$ 1.25
Attributable to Magna International Inc.	\$ 1.23	\$ 1.42	\$ 1.30	\$ 1.25
Diluted earnings per Common Share				
Continuing operations	\$ 1.22	\$ 1.41	\$ 1.29	\$ 1.24
Attributable to Magna International Inc.	\$ 1.22	\$ 1.41	\$ 1.29	\$ 1.24

	For the three month periods ended			
	Mar 31, 2015	Jun 30, 2015	Sep 30, 2015	Dec 31, 2015
Sales	\$ 7,772	\$ 8,133	\$ 7,661	\$ 8,568
Net income	\$ 464	\$ 480	\$ 588	\$ 475
Basic earnings per Common Share (restated)				
Continuing operations	\$ 1.11	\$ 1.31	\$ 1.15	\$ 1.20
Attributable to Magna International Inc.	\$ 1.14	\$ 1.18	\$ 1.44	\$ 1.18
Diluted earnings per Common Share (restated)				
Continuing operations	\$ 1.10	\$ 1.29	\$ 1.13	\$ 1.19
Attributable to Magna International Inc.	\$ 1.12	\$ 1.16	\$ 1.42	\$ 1.17

The third quarter of the year is generally affected by the normal seasonal effects of lower vehicle production volumes as a result of OEM summer shutdowns.

Included in the quarterly net income attributable to Magna International Inc. are the following Other Expense (Income), net items that have been discussed above:

	For the three month periods ended			
	Mar 31, 2016	Jun 30, 2016	Sep 30, 2016	Dec 31, 2016
Restructuring	\$ -	\$ -	\$ -	\$ 17
Pension settlement	-	-	-	13
	\$ -	\$ -	\$ -	\$ 30

	For the three month periods ended			
	Mar 31, 2015	Jun 30, 2015	Sep 30, 2015	Dec 31, 2015
Restructuring	\$ -	\$ -	\$ 12	\$ -
Gain on disposal	-	(57)	(136)	-
	\$ -	\$ (57)	\$ (124)	\$ 15

For more information regarding our quarter over quarter results, please refer to our first, second and third quarter 2016 quarterly reports which are available through the internet on the Canadian Securities Administrators' System for Electronic Document Analysis and Retrieval (SEDAR) which can be accessed at www.sedar.com.

FORWARD-LOOKING STATEMENTS

The previous discussion contains statements that constitute "forward-looking information" or "forward-looking statements" within the meaning of applicable securities legislation, including, but not limited to, statements relating to the expected growth of the Dual Clutch Transmission (DCT) product segment. The forward-looking statements or forward-looking information in this document is presented for the purpose of providing information about management's current expectations and plans and such information may not be appropriate for other purposes. Forward-looking statements or forward-looking information may include financial and other projections, as well as statements regarding our future plans, objectives or economic performance, or the assumptions underlying any of the foregoing, and other statements that are not recitations of historical fact. We use words such as "may", "would", "could", "should", "will", "likely", "expect", "anticipate", "believe", "intend", "plan", "forecast", "outlook", "project", "estimate" and similar expressions suggesting future outcomes or events to identify forward-looking statements or forward-looking information. Any such forward-looking statements or forward-looking information are based on information currently available to us, and are based on assumptions and analyses made by us in light of our experience and our perception of historical trends, current conditions and expected future developments, as well as other factors we believe are appropriate in the circumstances. However, whether actual results and developments will conform with our expectations and predictions is subject to a number of risks, assumptions and uncertainties, many of which are beyond our control, and the effects of which can be difficult to predict, including, without limitation: the potential for a deterioration of economic conditions or an extended period of economic uncertainty; a decline in consumer confidence, which would typically result in lower production volume levels; the growth of protectionism and the implementation of measures that impede the free movement of goods, services, people and capital; planning risks created by rapidly changing economic or political conditions; fluctuations in relative currency values; legal claims and/or regulatory actions against us, including without limitation any proceedings that may arise out of our global review focused on anti-trust risk; our ability to successfully launch material new or takeover business; underperformance of one or more of our operating divisions; ongoing pricing pressures, including our ability to offset price concessions demanded by our customers; warranty and recall costs; our ability to successfully identify, complete and integrate acquisitions or achieve anticipated synergies; our ability to conduct appropriate due diligence on acquisition targets; an increase in our risk profile as a result of completed acquisitions; shifts in market share away from our top customers; shifts in market shares among vehicles or vehicle segments, or shifts away from vehicles on which we have significant content; inability to sustain or grow our business; risks of conducting business in foreign markets, including China, India, Eastern Europe, Brazil and other non-traditional markets for us; our ability to successfully compete with other automotive suppliers, including disruptive technology innovators which are entering or expanding in the automotive industry; our ability to consistently develop innovative products or processes; our changing risk profile due to the increasing importance to us of product areas such as powertrain and electronics; restructuring, downsizing and/or other significant non-recurring costs; a reduction in outsourcing by our customers or the loss of a material production or assembly program; a prolonged disruption in the supply of components to us from our suppliers; shutdown of our or our customers' or sub-suppliers' production facilities due to a labour disruption; scheduled shutdowns of our customers' production facilities (typically in the third and fourth quarters of each calendar year); the termination or non-renewal by our customers of any material production purchase order; exposure to, and ability to offset, commodities price increases; restructuring actions by OEMs, including plant closures; work stoppages and labour relations disputes; risk of production disruptions due to natural disasters or catastrophic event; the security and reliability of our information technology systems; pension liabilities; changes in our mix of earnings between jurisdictions with lower tax rates and those with higher tax rates, as well as our ability to fully benefit tax losses; impairment charges related to goodwill, long-lived assets and deferred tax assets; other potential tax exposures; changes in credit ratings assigned to us; changes in laws and governmental regulations, including tax and transfer pricing laws; costs associated with compliance with environmental laws and regulations; liquidity risks; inability to achieve future investment returns that equal or exceed past returns; the unpredictability of, and fluctuation in, the trading price of our Common Shares; and other factors set out in our Annual Information Form filed with securities commissions in Canada and our annual report on Form 40-F filed with the United States Securities and Exchange Commission, and subsequent filings. In evaluating forward-looking statements or forward-looking information, we caution readers not to place undue reliance on any forward-looking statements or forward-looking information, and readers should specifically consider the various factors which could cause actual events or results to differ materially from those indicated by such forward-looking statements or forward-looking information. Unless otherwise required by applicable securities laws, we do not intend, nor do we undertake any obligation, to update or revise any forward-looking statements or forward-looking information to reflect subsequent information, events, results or circumstances or otherwise.

Report of Independent Registered Public Accounting Firm

To the Board of Directors and Shareholders of
Magna International Inc.

We have audited the accompanying consolidated balance sheets of Magna International Inc. and subsidiaries (the "Company") as of December 31, 2016 and 2015, and the related consolidated statements of income, comprehensive income, changes in equity and cash flows for the years ended December 31, 2016 and 2015. These financial statements are the responsibility of the Company's management. Our responsibility is to express an opinion on these financial statements based on our audits.

We conducted our audits in accordance with the standards of the Public Company Accounting Oversight Board (United States). Those standards require that we plan and perform the audit to obtain reasonable assurance about whether the financial statements are free of material misstatement. An audit includes examining, on a test basis, evidence supporting the amounts and disclosures in the financial statements. An audit also includes assessing the accounting principles used and significant estimates made by management, as well as evaluating the overall financial statement presentation. We believe that our audits provide a reasonable basis for our opinion.

In our opinion, such consolidated financial statements present fairly, in all material respects, the financial position of Magna International Inc. and subsidiaries as of December 31, 2016 and 2015, and the results of their operations and their cash flows for the years ended December 31, 2016 and 2015, in conformity with accounting principles generally accepted in the United States of America.

We have also audited, in accordance with the standards of the Public Company Accounting Oversight Board (United States), the Company's internal control over financial reporting as of December 31, 2016 based on criteria established in *Internal Control - Integrated Framework (2013)* issued by the Committee of Sponsoring Organizations of the Treadway Commission and our report dated March 9, 2017 expressed an unqualified opinion on the Company's internal control over financial reporting.

Deloitte LLP

Chartered Professional Accountants
Licensed Public Accountants
Toronto, Canada
March 9, 2017

Report of Independent Registered Public Accounting Firm

To the Board of Directors and Shareholders of
Magna International Inc.

We have audited the internal control over financial reporting of Magna International Inc. and subsidiaries (the "Company") as of December 31, 2016, based on the criteria established in *Internal Control – Integrated Framework (2013)* issued by the Committee of Sponsoring Organizations of the Treadway Commission. As described in Management's Annual Report on Internal Control over Financial Reporting, management excluded from its assessment the internal control over financial reporting the GETRAG Group of Companies ("GETRAG"), which was acquired on January 4, 2016. The excluded GETRAG financial statement amounts constitute 7% of total assets, 6% of sales and 2% of net income of the consolidated financial statement amounts as of and for the year ended December 31, 2016. Accordingly, our audit did not include the internal control over financial reporting at GETRAG. The Company's management is responsible for maintaining effective internal control over financial reporting and for its assessment of the effectiveness of internal control over financial reporting, included in the accompanying Management's Annual Report on Internal Control over Financial Reporting. Our responsibility is to express an opinion on the Company's internal control over financial reporting based on our audit.

We conducted our audit in accordance with the standards of the Public Company Accounting Oversight Board (United States). Those standards require that we plan and perform the audit to obtain reasonable assurance about whether effective internal control over financial reporting was maintained in all material respects. Our audit included obtaining an understanding of internal control over financial reporting, assessing the risk that a material weakness exists, testing and evaluating the design and operating effectiveness of internal control based on the assessed risk, and performing such other procedures as we considered necessary in the circumstances. We believe that our audit provides a reasonable basis for our opinion.

A company's internal control over financial reporting is a process designed by, or under the supervision of, the company's principal executive and principal financial officers, or persons performing similar functions, and effected by the company's board of directors, management, and other personnel to provide reasonable assurance regarding the reliability of financial reporting and the preparation of financial statements for external purposes in accordance with generally accepted accounting principles. A company's internal control over financial reporting includes those policies and procedures that (1) pertain to the maintenance of records that, in reasonable detail, accurately and fairly reflect the transactions and dispositions of the assets of the company; (2) provide reasonable assurance that transactions are recorded as necessary to permit preparation of financial statements in accordance with generally accepted accounting principles, and that receipts and expenditures of the company are being made only in accordance with authorizations of management and directors of the company; and (3) provide reasonable assurance regarding prevention or timely detection of unauthorized acquisition, use, or disposition of the company's assets that could have a material effect on the consolidated financial statements.

Because of the inherent limitations of internal control over financial reporting, including the possibility of collusion or improper management override of controls, material misstatements due to error or fraud may not be prevented or detected on a timely basis. Also, projections of any evaluation of the effectiveness of the internal control over financial reporting to future periods are subject to the risk that the controls may become inadequate because of changes in conditions, or that the degree of compliance with the policies or procedures may deteriorate.

In our opinion, the Company maintained, in all material respects, effective internal control over financial reporting as of December 31, 2016, based on the criteria established in *Internal Control – Integrated Framework (2013)* issued by the Committee of Sponsoring Organizations of the Treadway Commission.

We have also audited, in accordance with the standards of the Public Company Accounting Oversight Board (United States), the consolidated financial statements as of and for the year ended December 31, 2016 of the Company and our report dated March 9, 2017 expressed an unqualified opinion on those financial statements.

Deloitte LLP

Chartered Professional Accountants
Licensed Public Accountants
Toronto, Canada
March 9, 2017

MAGNA INTERNATIONAL INC.
Consolidated Statements of Income

[U.S. dollars in millions, except per share figures]

Years ended December 31,

	Note	2016	2015
Sales		\$ 36,445	\$ 32,134
Costs and expenses			
Cost of goods sold		31,123	27,559
Depreciation and amortization		1,056	802
Selling, general and administrative		1,601	1,448
Interest expense, net	17	88	44
Equity income		(233)	(204)
Other expense (income), net	4	30	(166)
Income from continuing operations before income taxes		2,780	2,651
Income taxes	12	706	711
Net income from continuing operations		2,074	1,940
Income from discontinued operations, net of tax		–	67
Net income		2,074	2,007
(Income) loss from continuing operations attributable to non-controlling interests		(43)	6
Net income attributable to Magna International Inc.		\$ 2,031	\$ 2,013
Basic Earnings per Common Share:	5		
Continuing operations		\$ 5.19	\$ 4.78
Discontinued operations		–	0.16
Attributable to Magna International Inc.		\$ 5.19	\$ 4.94
Diluted Earnings per Common Share:	5		
Continuing operations		\$ 5.16	\$ 4.72
Discontinued operations		–	0.16
Attributable to Magna International Inc.		\$ 5.16	\$ 4.88
Weighted average number of Common Shares outstanding during the year [in millions]:	5		
Basic		391.0	407.5
Diluted		393.2	412.7

See accompanying notes

MAGNA INTERNATIONAL INC.

Consolidated Statements of Comprehensive Income*[U.S. dollars in millions]*

Years ended December 31,

	Note	2016	2015
Net income		\$ 2,074	\$ 2,007
Other comprehensive loss, net of tax:	21		
Net unrealized loss on translation of net investment in foreign operations		(134)	(800)
Net unrealized gain (loss) on cash flow hedges		1	(244)
Reclassification of net loss on cash flow hedges to net income		126	95
Reclassification of net loss on investments to net income		1	3
Reclassification of net loss on pensions to net income		9	7
Pension and post-retirement benefits		(29)	14
Other comprehensive loss		(26)	(925)
Comprehensive income		2,048	1,082
Comprehensive (income) loss attributable to non-controlling interests		(18)	8
Comprehensive income attributable to Magna International Inc.		\$ 2,030	\$ 1,090

See accompanying notes

MAGNA INTERNATIONAL INC.
Consolidated Balance Sheets

[U.S. dollars in millions, except per share figures]

As at December 31,

	Note	2016	2015
ASSETS			
Current assets			
Cash and cash equivalents	6	\$ 974	\$ 2,863
Accounts receivable		6,165	5,439
Inventories	8	2,804	2,564
Prepaid expenses and other		220	278
		10,163	11,144
Investments	9, 18, 22	1,850	399
Fixed assets, net	10	7,022	5,948
Intangible assets, net	13	621	169
Goodwill	7, 11	1,923	1,344
Deferred tax assets	12	268	271
Other assets	14, 18	719	412
		\$ 22,566	\$ 19,687
LIABILITIES AND SHAREHOLDERS' EQUITY			
Current liabilities			
Short-term borrowings	17	\$ 623	\$ 25
Accounts payable		5,430	4,746
Accrued salaries and wages	15	768	660
Other accrued liabilities	16	1,639	1,512
Income taxes payable		96	122
Long-term debt due within one year	17	139	211
		8,695	7,276
Long-term debt	17	2,394	2,327
Long-term employee benefit liabilities	18	667	504
Other long-term liabilities	19	298	331
Deferred tax liabilities	12	293	132
		12,347	10,570
Shareholders' equity			
Common Shares [issued: 382,252,522; 2015 – 402,264,201]	20	3,796	3,942
Contributed surplus		105	107
Retained earnings	20	7,318	6,387
Accumulated other comprehensive loss	21	(1,451)	(1,470)
		9,768	8,966
Non-controlling interests		451	151
		10,219	9,117
		\$ 22,566	\$ 19,687

Commitments and contingencies [notes 17, 22 and 23]

See accompanying notes

On behalf of the Board:

Lawrence D. Worrall
 Director

William L. Young
 Chairman of the Board

MAGNA INTERNATIONAL INC.
Consolidated Statements of Cash Flows

[U.S. dollars in millions]

Years ended December 31,

	Note	2016	2015
OPERATING ACTIVITIES			
Net income from continuing operations		\$ 2,074	\$ 1,940
Items not involving current cash flows	6	1,231	736
		3,305	2,676
Changes in operating assets and liabilities	6	81	(344)
Cash provided from operating activities		3,386	2,332
INVESTMENT ACTIVITIES			
Fixed asset additions		(1,807)	(1,591)
Purchase of subsidiaries	7	(1,930)	(222)
Increase in investments and other assets		(478)	(221)
Increase in restricted cash deposits		(194)	–
Proceeds from disposition		138	61
Proceeds on disposal of facilities	4	–	221
Sale of Interiors		–	520
Cash used in discontinued operations		–	(56)
Cash used for investment activities		(4,271)	(1,288)
FINANCING ACTIVITIES			
Issues of debt	17	282	1,608
Increase in short-term borrowings		386	25
Repayments of debt	17	(417)	(99)
Issues of Common Shares on exercise of stock options		33	35
Repurchase of Common Shares	20	(913)	(515)
Contributions to subsidiaries by non-controlling interests		(1)	41
Dividends paid to non-controlling interests		(5)	–
Dividends paid		(385)	(354)
Cash (used for) provided from financing activities		(1,020)	741
Effect of exchange rate changes on cash and cash equivalents		16	(171)
Net (decrease) increase in cash and cash equivalents during the year		(1,889)	1,614
Cash and cash equivalents, beginning of year		2,863	1,249
Cash and cash equivalents, end of year		\$ 974	\$ 2,863

See accompanying notes

Consolidated Statements of Changes in Equity*[U.S. dollars in millions, except number of common shares]*

	Common Shares		Contri-	Retained	AOCL ^[i]	Non-	Total
	Number	Stated Value	buted Surplus	Earnings		controlling Interests	Equity
	<i>[in millions]</i>						
Balance, December 31, 2014	410.3	\$ 3,979	\$ 83	\$ 5,155	\$ (558)	\$ 14	\$ 8,673
Net income				2,013		(6)	2,007
Other comprehensive loss					(923)	(2)	(925)
Shares issued on exercise of stock options	2.4	45	(10)				35
Release of stock and stock units	0.5	17	(17)				–
Repurchase and cancellation under normal course issuer bids <i>[note 20]</i>	(11.1)	(108)		(418)	11		(515)
Contribution by non-controlling interests <i>[note 7]</i>			17			29	46
Purchase of non-controlling interests <i>[note 7]</i>			(2)				(2)
Acquisitions <i>[note 7]</i>						116	116
Stock-based compensation expense			36				36
Dividends paid [\$0.88 per share]	0.2	9		(363)			(354)
Balance, December 31, 2015	402.3	3,942	107	6,387	(1,470)	151	9,117
Net income				2,031		43	2,074
Other comprehensive loss					(1)	(25)	(26)
Shares issued on exercise of stock options	2.1	47	(14)				33
Release of stock and stock units	0.4	25	(25)				–
Repurchase and cancellation under normal course issuer bids <i>[note 20]</i>	(22.6)	(222)		(711)	20		(913)
Contribution by non-controlling interests <i>[note 7]</i>						(1)	(1)
Acquisitions <i>[note 7]</i>						288	288
Stock-based compensation expense			37				37
Dividends paid to non-controlling interests						(5)	(5)
Dividends paid [\$1.00 per share]	0.1	4		(389)			(385)
Balance, December 31, 2016	382.3	\$ 3,796	\$ 105	\$ 7,318	\$ (1,451)	\$ 451	\$ 10,219

*[i] AOCL is Accumulated Other Comprehensive Loss.**See accompanying notes*

Notes to Consolidated Financial Statements

[All amounts in U.S. dollars and all tabular amounts in millions, except per share figures, unless otherwise noted]

1. SIGNIFICANT ACCOUNTING POLICIES

Magna International Inc. [collectively "Magna" or the "Company"] is a global automotive supplier whose product capabilities include producing body, chassis, exterior, seating, powertrain, electronic, active driver assistance, vision, closure and roof systems and modules, as well as complete vehicle engineering and contract manufacturing.

The consolidated financial statements have been prepared in U.S. dollars following accounting principles generally accepted in the United States ["GAAP"].

Principles of consolidation

The Consolidated Financial Statements include the accounts of Magna and its subsidiaries in which Magna has a controlling financial interest or is the primary beneficiary. Magna accounts for investments in companies over which it has the ability to exercise significant influence but does not hold a controlling interest under the equity method, and records its proportionate share of income or losses in Equity income in the Consolidated Statements of Income. The Company presents non-controlling interests as a separate component within Shareholders' equity in the Consolidated Balance Sheets.

Financial instruments

The Company classifies all of its financial assets and financial liabilities as trading, held-to-maturity investments, loans and receivables, available-for-sale financial assets, or other financial liabilities. Held-for-trading financial instruments, which include cash and cash equivalents and the Company's investment in asset-backed commercial paper ["ABCP"] are measured at fair value and all gains and losses are included in net income in the period in which they arise. Held-to-maturity investments, which include long-term interest bearing government securities held to partially fund certain Austrian lump sum termination and long service payment arrangements, are recorded at amortized cost using the effective interest method. Loans and receivables, which include accounts receivable, long-term receivables and accounts payable, are recorded at amortized cost using the effective interest method. Available-for-sale financial assets are recorded at cost and are subsequently measured at fair value with all revaluation gains and losses included in other comprehensive income.

Foreign currency translation

The Company operates globally, which gives rise to a risk that its earnings and cash flows may be adversely impacted by fluctuations in foreign exchange rates.

Assets and liabilities of the Company's operations having a functional currency other than the U.S. dollar are translated into U.S. dollars using the exchange rate in effect at year end, and revenues and expenses are translated at the average rate during the year. Exchange gains or losses on translation of the Company's net investment in these operations are included in comprehensive income and are deferred in accumulated other comprehensive income. Foreign exchange gains or losses on debt that was designated as a hedge of the Company's net investment in these operations are also recorded in accumulated other comprehensive income.

Foreign exchange gains and losses on transactions occurring in a currency other than an operation's functional currency are reflected in income, except for gains and losses on foreign exchange contracts used to hedge specific future commitments in foreign currencies and on intercompany balances which are designated as long-term investments. In particular, the Company uses foreign exchange forward contracts for the sole purpose of hedging certain of the Company's future committed foreign currency based outflows and inflows. Most of the Company's foreign exchange contracts are subject to master netting arrangements that provide for the net settlement of contracts, by counterparty, in the event of default or termination. All derivative instruments, including foreign exchange contracts, are recorded on the consolidated balance sheet at fair value. The fair values of derivatives are recorded on a gross basis in prepaid expenses and other, other assets, other accrued liabilities or other long-term liabilities. To the extent that cash flow hedges are effective, the change in their fair value is recorded in other comprehensive income; any ineffective portion is recorded in net income. Amounts accumulated in other comprehensive income are reclassified to net income in the period in which the hedged item affects net income.

If the Company's foreign exchange forward contracts cease to be effective as hedges, for example, if projected foreign cash inflows or outflows declined significantly, gains or losses pertaining to the portion of the hedging transactions in excess of projected foreign currency denominated cash flows would be recognized in income at the time this condition was identified.

Cash and cash equivalents

Cash and cash equivalents include cash on account, demand deposits and short-term investments with remaining maturities of less than three months at acquisition.

Inventories

Production inventories and tooling inventories manufactured in-house are valued at the lower of cost and market, with cost being determined substantially on a first-in, first-out basis. Cost includes the cost of materials plus direct labour applied to the product and the applicable share of manufacturing overhead.

Outsourced tooling inventories are valued at the lower of subcontracted costs and market.

Long-lived assets

Fixed assets are recorded at historical cost. Depreciation is provided on a straight-line basis over the estimated useful lives of fixed assets at annual rates of 2½% to 5% for buildings, 7% to 10% for general purpose equipment and 10% to 33% for special purpose equipment.

Definite-lived intangible assets, which have arisen principally through acquisitions and include customer relationship intangibles and patents and licences. These definite-lived intangible assets are amortized on a straight-line basis over their estimated useful lives which range from 4 to 15 years.

The Company assesses fixed and definite-lived intangible assets for recoverability whenever indicators of impairment exist. If the carrying value of the asset exceeds the estimated undiscounted cash flows from the use of the asset, then an impairment loss is recognized to write the asset down to fair value. The fair value of fixed and definite-lived intangible assets is generally determined using estimated discounted future cash flows.

Goodwill

Goodwill represents the excess of the cost of an acquired enterprise over the fair value of the identifiable assets acquired and liabilities assumed less any subsequent write-downs for impairment. Goodwill is reviewed for impairment in the fourth quarter of each year, or more frequently if indicators of potential impairment exist. Goodwill impairment is assessed based on a comparison of the fair value of a reporting unit to the underlying carrying value of the reporting unit's net assets, including goodwill. When the carrying amount of the reporting unit exceeds its fair value, the fair value of the reporting unit's goodwill is compared with its carrying amount to measure the amount of impairment, if any. The fair value of a reporting unit is determined using the estimated discounted future cash flows of the reporting unit.

Other assets

Other assets include the long-term portion of certain receivables, which represent the recognized sales value of tooling and design and engineering services provided to customers under certain long-term contracts. The receivables will be paid in full upon completion of the contracts or in instalments based on forecasted production volumes. In the event that actual production volumes are less than those forecasted, a reimbursement for any shortfall will be made.

Preproduction costs related to long-term supply agreements

Pre-operating costs incurred in establishing new facilities that require substantial time to reach commercial production capability are expensed as incurred.

Costs incurred [net of customer subsidies] related to design and engineering, which are paid for as part of subsequent production piece price amounts, are expensed as incurred unless a contractual guarantee for reimbursement exists.

Costs incurred [net of customer subsidies] related to design and development costs for moulds, dies and other tools that the Company does not own [and that will be used in, and paid for as part of the piece price amount for, subsequent production] are expensed as incurred unless the supply agreement provides a contractual guarantee for reimbursement or the non-cancellable right to use the moulds, dies and other tools during the supply agreement.

Where these preproduction costs are deemed to be a single unit of account combined with a subsequent parts production, the costs deferred in the above circumstances are included in other assets and amortized on a units-of-production basis to cost of goods sold over the anticipated term of the supply agreement.

Warranty

The Company records product warranty liabilities based on its individual customer agreements. Under most customer agreements, the Company only accounts for existing or probable claims on product default issues when amounts related to such issues are probable and reasonably estimable. Under certain powertrain and complete vehicle engineering and assembly contracts, the Company records an estimate of future warranty-related costs based on the terms of the specific customer agreements and the specific customer's warranty experience.

Product liability provisions are established based on the Company's best estimate of the amounts necessary to settle existing claims on product default issues. Recall costs are costs incurred when government regulators and/or the customer decides to recall a product due to a known or suspected performance issue, and the Company is required to participate, either voluntarily or involuntarily. Costs typically include the cost of the product being replaced, the customer's cost of the recall and labour to remove and replace the defective part. When a decision to recall a product has been made or is probable, the Company's portion of the estimated cost of the recall is recorded as a charge to income in that period. In making this estimate, judgment is required as to the number of units that may be returned as a result of the recall, the total cost of the recall campaign and the ultimate negotiated sharing of the cost between the Company, the customer and, in some cases, a supplier to the Company.

The Company monitors warranty activity on an ongoing basis and adjusts reserve estimates when it is probable that future warranty costs will be different than those estimates.

Employee future benefit plans

The cost of providing benefits through defined benefit pensions, lump sum termination and long service payment arrangements, and post-retirement benefits other than pensions is actuarially determined and recognized in income using the projected benefit method pro-rated on service and management's best estimate of expected plan investment performance, salary escalation, retirement ages of employees and, with respect to medical benefits, expected health care costs. Differences arising from plan amendments, changes in assumptions and experience gains and losses that are greater than 10% of the greater of the accrued benefit obligation at the beginning of the year and the fair value, or market related value, of plan assets at the beginning of the year, are recognized in income over the expected average remaining service life of employees. Gains related to plan curtailments are recognized when the event giving rise to the curtailment has occurred. Plan assets are valued at fair value. The cost of providing benefits through defined contribution pension plans is charged to income in the period in respect of which contributions become payable.

The funded status of the plans is measured as the difference between the plan assets at fair value and the projected benefit obligation ["PBO"]. The aggregate of all overfunded plans is recorded in other assets, and the aggregate of all underfunded plans in long-term employee benefit liabilities. The portion of the amount by which the actuarial present value of benefits included in the PBO exceeds the fair value of plan assets, payable in the next twelve months, is reflected in other accrued liabilities. This is determined on a plan by plan basis.

Asset retirement obligation

The Company recognizes its obligation to restore leased premises at the end of the lease by recording at lease inception the estimated fair value of this obligation as other long-term liabilities with a corresponding amount recognized as fixed assets. The fixed asset amount is amortized over the period from lease inception to the time the Company expects to vacate the premises, resulting in both depreciation and interest charges. The estimated fair value of the obligation is assessed for changes in the expected timing and extent of expenditures with changes related to the time value of money recorded as interest expense.

Revenue recognition

Revenue from the sale of manufactured products is recognized when the price is fixed or determinable, collectability is reasonably assured and upon shipment to [or receipt by customers, depending on contractual terms], and acceptance by customers.

Revenue from tooling and engineering services are accounted for as a separate revenue element only in circumstances where the tooling and engineering has value to the customer on a standalone basis. Revenues from significant engineering services and tooling contracts that qualify as separate revenue elements are recognized on a percentage of completion basis. Percentage-of-completion is generally determined based on the proportion of accumulated expenditures to date as compared to total anticipated expenditures.

Revenue and cost of goods sold, including amounts from engineering and tooling contracts, are presented on a gross basis in the consolidated statements of income and comprehensive income when the Company is acting as principal and is subject to significant risks and rewards in connection with the process of bringing the product to its final state and in the post-sale dealings with its customers. Otherwise, components of revenues and related costs are presented on a net basis.

With respect to vehicle assembly sales, given that Magna is acting as principal with respect to purchased components and systems, the selling price to the customer includes the costs of such inputs.

Government assistance

The Company makes periodic applications for financial assistance under available government assistance programs in the various jurisdictions that the Company operates. Grants relating to capital expenditures are reflected as a reduction of the cost of the related assets. Grants relating to current operating expenditures are generally recorded as a reduction of the related expense at the time the eligible expenses are incurred. The Company also receives tax credits and tax super allowances, the benefits of which are recorded as a reduction of income tax expense. In addition, the Company receives loans which are recorded as liabilities in amounts equal to the cash received. When a government loan is issued to the Company at a below-market rate of interest, the loan is initially recorded at its net present value, and accreted to its face value over the period of the loan. The benefit of the below-market rate of interest is accounted for like a government grant. It is measured as the difference between the initial carrying value of the loan and the cash proceeds received.

Income taxes

The Company uses the liability method of tax allocation to account for income taxes. Under the liability method of tax allocation, deferred tax assets and liabilities are determined based on differences between the financial reporting and tax bases of assets and liabilities and are measured using the enacted tax rates and laws that will be in effect when the differences are expected to reverse.

No deferred tax liability is recorded for taxes on undistributed earnings and translation adjustments of foreign subsidiaries if these items are either considered to be reinvested for the foreseeable future or if they are available for repatriation and are not subject to further tax on remittance. Taxes are recorded on such foreign undistributed earnings and translation adjustments when it becomes apparent that such earnings will be distributed in the foreseeable future and the Company will incur further significant tax on remittance.

Recognition of uncertain tax positions is dependent on whether it is more-likely-than-not that a tax position taken or expected to be taken in a tax return will be sustained upon examination, including resolution of any related appeals or litigation processes, based on the technical merits of the position. A tax position that meets the more-likely-than-not recognition threshold is measured at the largest amount of tax benefit that is greater than 50% likely of being realized upon ultimate settlement. The Company recognizes interest and penalties related to uncertain tax positions in income tax expense.

Comprehensive income

Other comprehensive income includes unrealized gains and losses on translation of the Company's foreign operations that use the local currency as the functional currency, the change in fair value of available-for-sale investments, net of taxes, the change in unamortized actuarial amounts, net of taxes and to the extent that cash flow hedges are effective, the change in their fair value, net of income taxes.

Accumulated other comprehensive income is a separate component of shareholders' equity which includes the accumulated balances of all components of other comprehensive income which are recognized in comprehensive income but excluded from net income.

Earnings per Common Share

Basic earnings per Common Share are calculated on net income attributable to Magna International Inc. using the weighted average number of Common Shares outstanding during the year.

Diluted earnings per Common Share are calculated on the weighted average number of Common Shares outstanding, including an adjustment for stock options outstanding using the treasury stock method.

Common Shares that have not been released under the Company's restricted stock plan or are being held in trust for purposes of the Company's restricted stock unit program have been excluded from the calculation of basic earnings per share but have been included in the calculation of diluted earnings per share.

Discontinued operations

The Company reports financial results for discontinued operations separately from continuing operations to distinguish the financial impact of disposal transactions from ongoing operations. Discontinued operations reporting only occurs when the disposal of a component or a group of components of the Company represents a strategic shift that will have a major impact on the Company's operations and financial results. In the third quarter of 2015, the Company sold substantially all of its interiors operations. Accordingly, for the year ended December 31, 2015 the operating results and operating cash flows for the disposed interiors operations are presented as discontinued operations separate from the Company's continuing operations. Financial information related to the interiors operations has been excluded from both continuing operations and segment results in the consolidated financial statements. Refer to Note 3 Discontinued Operations for further information regarding the Company's discontinued operations.

Use of estimates

The preparation of the consolidated financial statements in conformity with GAAP requires management to make estimates and assumptions that affect the amounts reported and disclosed in the consolidated financial statements and accompanying notes. Actual results could differ from those estimates.

2. ACCOUNTING STANDARDS

Accounting Changes

Pension and other Post-Retirement Benefit Plans

At December 31, 2016, the Company changed the method used to estimate the service and interest components of net periodic benefit cost for pension and other post-retirement benefits for plans that utilize a yield curve approach. This change compared to the previous method will result in different service and interest components of net periodic benefit cost (credit) in future periods. Historically, the Company estimated these service and interest cost components utilizing a single weighted-average discount rate derived from the yield curve used to measure the benefit obligation at the beginning of the period. The Company elected to utilize a full yield curve approach in the estimation of these components by applying the specific spot rates along the yield curve used in the determination of the benefit obligation to the relevant projected cash flows. The Company made this change to provide a more precise measurement of service and interest costs by improving the correlation between projected benefit cash flows to the corresponding spot yield curve rates. This change does not affect the measurement of the total benefit obligations or annual net periodic benefit cost (credit) as the change in the service and interest costs is completely offset in the net actuarial (gain) loss reported. The change in the service and interest costs was not significant. The Company has accounted for this change as a change in accounting estimate.

Simplifying the Presentation of Debt Issuance Costs

In the first quarter of 2016, the Company adopted Accounting Standards Update No. 2015-03 "Interest - Imputation of Interest (Subtopic 835-30): Simplifying the Presentation of Debt Issuance Costs". This guidance requires that debt issuance costs be presented as a direct reduction to the carrying amount of the related debt in the balance sheet rather than as an asset. Consequently, the Company has reclassified \$19 million of deferred debt issuance costs from other assets to long-term debt in the consolidated balance sheet as at December 31, 2015.

Future Accounting Standards

Revenue Recognition

In May 2014, the FASB issued ASU No. 2014-09, "Revenue from Contracts with Customers: Topic 606 (ASU 2014-09)", to supersede nearly all existing revenue recognition guidance under GAAP. The core principle of ASU 2014-09 is to recognize revenues when promised goods or services are transferred to customers in an amount that reflects the consideration that is expected to be received for those goods or services. In July 2015, the FASB deferred the effective date to annual reporting periods beginning after December 15, 2017 [including interim reporting periods within those periods]. ASU 2014-09 is effective for the Company in the first quarter of fiscal 2018 using either of two methods: [i] retrospective to each prior reporting period presented with the option to elect certain practical expedients as defined within ASU 2014-09; or [ii] retrospective with the cumulative effect of initially applying ASU 2014-09 recognized at the date of initial application and providing certain additional disclosures as defined per ASU 2014-09. The Company has not yet selected a transition method and continues to evaluate the impact that ASU 2014-09 will have on its consolidated financial statements and related disclosures. In addition, new controls and processes designed to comply with ASU 2014-09 will be implemented and tested throughout 2017 to permit adoption by January 1, 2018.

Leases

In February 2016, the FASB issued ASU No. 2016-02, "Leases: Topic 842 (ASU 2016-02)", to supersede nearly all existing lease guidance under GAAP. The guidance would require lessees to recognize most leases on their balance sheets as lease liabilities with corresponding right-of-use assets. ASU 2016-02 is effective for the Company in the first quarter of fiscal 2019 using a modified retrospective approach with the option to elect certain practical expedients. Early adoption is permitted. The Company is currently evaluating the impact of ASU 2016-02 on its consolidated financial statements.

Statement of Cash Flows

In November 2016, the FASB issued ASU 2016-18, Statement of Cash Flows (Topic 230): Restricted Cash (ASU 2016-18), which provides amendments to current guidance to address the classification and presentation of changes in restricted cash in the statement of cash flows. ASU 2016-18 is effective for the Company in the first quarter of fiscal 2018 and earlier adoption is permitted. The Company is currently evaluating the impact of the adoption of ASU 2016-18 on its consolidated financial statements.

Income Taxes

In October 2016, the FASB issued ASU No. 2016-16, *Accounting for Income Taxes: Intra-Entity Asset Transfers of Assets Other than Inventory*. This guidance requires that the tax effects of all intra-entity sales of assets other than inventory be recognized in the period in which the transaction occurs. The new guidance is effective for fiscal years beginning after December 15, 2017, and interim periods within those fiscal years. Early adoption as of the beginning of an annual reporting period is permitted. The guidance is to be applied on a modified retrospective basis through a cumulative-effect adjustment to retained earnings as of the beginning of the period of adoption. The adoption of this guidance is not expected to have a significant impact on the Company's consolidated financial statements.

Goodwill

In January 2017, the FASB issued new guidance, ASU No. 2017-4, *Intangibles-Goodwill and Other (Topic 350): Simplifying the test for Goodwill Impairment*. This guidance simplifies subsequent goodwill measurement by eliminating Step 2 from the goodwill impairment test. Under this update, an entity should perform its annual, or interim, goodwill impairment test by comparing the fair value of a reporting unit with its carrying amount. An entity should recognize an impairment charge for the amount by which the carrying amount exceeds the reporting unit's fair value; however, the loss recognized should not exceed the total amount of goodwill allocated to that reporting unit. The new standard is effective for annual periods, and interim periods within those annual periods, beginning after December 15, 2019 with early adoption permitted for annual goodwill impairment tests performed after January 1, 2017. The standard must be applied prospectively. Upon adoption, the standard will impact how the Company assesses goodwill for impairment. The adoption of this guidance is not expected to have a significant impact on the Company's consolidated financial statements.

3. DISCONTINUED OPERATIONS

On August 31, 2015, the Company sold substantially all of its interiors operations ["the interiors operations"]. The Company recognized a gain on the divestiture within income from discontinued operations as follows:

Proceeds on disposal, net of transaction costs	\$ 549
Net assets disposed	438
Pre-tax gain on divestiture	111
Income taxes	66
Gain on divestiture, net of tax	\$ 45

There were no amounts related to the interiors operations classified as discontinued operations for the year ended December 31, 2016. The following table summarizes the results of the interiors operations classified as discontinued operations for the year ended December 31, 2015:

	2015
Sales	\$ 1,737
Costs and expenses	
Cost of goods sold	1,635
Depreciation and amortization	13
Selling, general and administrative	58
Equity income	(11)
Income from discontinued operations before income taxes and gain on divestiture	42
Income taxes	20
Income from discontinued operations before gain on divestiture	22
Gain on divestiture of discontinued operations, net of tax	45
Income from discontinued operations, net of tax	\$ 67

The interiors operations were previously included within all of the Company's reporting segments except for Rest of World.

4. OTHER EXPENSE (INCOME), NET

Other expense (income), net consists of significant items such as: restructuring charges generally related to significant plant closures or consolidations; impairment charges; gains or losses on disposal of facilities; re-measurement gains on acquisitions; and other items not reflective of on-going operating profit or loss. Other expense (income), net consists of:

	2016	2015
North America [a]		
Gain on disposal of Bestop	\$ –	\$ (136)
Pension settlement	13	–
	13	(136)
Europe [b]		
Restructuring charges	17	27
Gain on disposal of battery pack business	–	(57)
	17	(30)
	\$ 30	\$ (166)

[a] North America

For the year ended December 31, 2016

During the fourth quarter of 2016, the Company offered a limited lump-sum payout to certain terminated vested plan participants of its U.S. defined benefit pension plans. As a result of the partial settlement, the Company recognized a \$13 million [\$9 million after tax] non-cash settlement charge.

For the year ended December 31, 2015

During 2015, the Company entered into a joint venture arrangement for the manufacture and sale of roof and other accessories for the Jeep market to original equipment manufacturers as well as aftermarket customers. The Company contributed two manufacturing facilities and received a 49% interest in the newly formed joint venture and cash proceeds of \$118 million. Total consideration was valued at \$160 million and as a result the Company recognized a gain of \$136 million [\$80 million after tax]. The Company accounts for its ownership as an equity investment since Magna has significant influence through its voting rights, but does not control the joint venture.

[b] Europe

For the year ended December 31, 2016

During 2016, the Company recorded net restructuring charges of \$17 million [\$17 million after tax] in Germany at a powertrain systems facility.

For the year ended December 31, 2015

During 2015, the Company recorded net restructuring charges of \$27 million [\$27 million after tax] primarily in Germany at its exterior systems and roof systems operations.

During 2015, the Company sold its battery pack business to Samsung SDI for gross proceeds of approximately \$120 million, resulting in a gain of \$57 million [\$42 million after tax].

5. EARNINGS PER SHARE

Earnings per share are computed as follows:

	2016	2015
Income available to Common shareholders:		
Net income from continuing operations	\$ 2,074	\$ 1,940
(Income) loss from continuing operations attributable to non-controlling interests	(43)	6
Net income attributable to Magna International Inc. from continuing operations	2,031	1,946
Income from discontinued operations, net of tax	–	67
Net income attributable to Magna International Inc.	\$ 2,031	\$ 2,013
Weighted average shares outstanding:		
Basic	391.0	407.5
Adjustments		
Stock options and restricted stock [a]	2.2	5.2
Diluted	393.2	412.7

[a] Diluted earnings per Common Share exclude 3.4 million [2015 – 0.9 million] Common Shares issuable under the Company's Incentive Stock Option Plan because these options were not "in-the-money".

Earnings per Common Share:

	2016	2015
Basic:		
Continuing operations	\$ 5.19	\$ 4.78
Discontinued operations	–	0.16
Attributable to Magna International Inc.	\$ 5.19	\$ 4.94
Diluted:		
Continuing operations	\$ 5.16	\$ 4.72
Discontinued operations	–	0.16
Attributable to Magna International Inc.	\$ 5.16	\$ 4.88

The dilutive effect of participating securities using the two-class method was excluded from the calculation of earnings per share because the effect would be immaterial.

6. DETAILS OF CASH FROM OPERATING ACTIVITIES

[a] Cash and cash equivalents consist of:

	2016	2015
Bank term deposits, bankers' acceptances and government paper	\$ 498	\$ 2,572
Cash	476	291
	\$ 974	\$ 2,863

[b] Items not involving current cash flows:

	2016	2015
Depreciation and amortization	\$ 1,056	\$ 802
Amortization of other assets included in cost of goods sold	135	110
Other non-cash charges	27	44
Deferred income taxes [note 12]	22	(7)
Equity income in excess of dividends received	(9)	(20)
Non-cash portion of Other (income) expense, net [note 4]	–	(193)
	\$ 1,231	\$ 736

[c] Changes in operating assets and liabilities:

	2016	2015
Accounts receivable	\$ (446)	\$ (410)
Inventories	(159)	(241)
Prepaid expenses and other	189	13
Accounts payable	562	139
Accrued salaries and wages	94	43
Other accrued liabilities	(145)	72
Income taxes payable	(14)	40
	\$ 81	\$ (344)

7. ACQUISITIONS

Acquisitions in the year ended December 31, 2016

On January 4, 2016, the Company completed the acquisition of 100% of the common shares and voting interests of the GETRAG Group of Companies ["GETRAG"]. GETRAG is a global supplier of automotive transmission systems, including manual, automated-manual, dual clutch, hybrid and other advanced systems. The purchase price was \$1.9 billion [net of \$136 million cash acquired]. The acquired business has sales primarily to BMW, Audi, Jiangling Motors, Ford, Volvo and Dongfeng.

The acquisition of GETRAG was accounted for as a business combination. The following table summarizes the amounts recognized for assets acquired and liabilities assumed:

	Preliminary amounts recognized at March 31, 2016	Measurement period adjustments	Final allocation
Cash	\$ 136	\$ –	\$ 136
Non-cash working capital	(466)	71	(395)
Investments	1,719	(222)	1,497
Fixed assets	468	(23)	445
Goodwill	430	160	590
Other assets	60	(36)	24
Intangibles	218	154	372
Deferred tax assets	43	(9)	34
Long-term employee benefit liabilities	(125)	(12)	(137)
Long-term debt	(116)	(1)	(117)
Other long-term liabilities	(9)	(43)	(52)
Deferred tax liabilities	(137)	18	(119)
Non-controlling interest	(303)	16	(287)
Consideration paid	1,918	73	1,991
Less: Cash acquired	(136)	–	(136)
Net cash outflow	\$ 1,782	\$ 73	\$ 1,855

The measurement period adjustments primarily reflect: [i] changes in the estimated fair value of the acquired equity method investments; [ii] changes in the estimated fair value of the acquired patents and customer relationship intangibles; and [iii] a working capital adjustment due to an increase in the total fair value of consideration transferred. This resulted in a net adjustment to goodwill of \$160 million.

The measurement period adjustments did not result from intervening events subsequent to the acquisition date and did not have a material impact on the Company's earnings in any period. The final allocation of the consideration transferred to the assets acquired and liabilities assumed has been completed.

The investments amount includes the following equity investments that were acquired as part of the business combination:

	Ownership percentage	Investment balance
GETRAG Ford Transmission GmbH ["GFT"]	50.0%	\$ 340
GETRAG (Jiangxi) Transmission Co., Ltd ["GJT"] ^[i]	50.0%	\$ 1,077
Dongfeng GETRAG Transmission Co. Ltd ["DGT"]	50.0%	\$ 80

[i] GJT is 66.7% owned by one of the Company's consolidated subsidiaries which has a 25% non-controlling interest. As a result, the investment balance was derived using 66.7% of the fair value.

The Company accounts for the investments under the equity method since it has the ability to exercise significant influence but does not hold a controlling financial interest.

Recognized goodwill is attributable to the assembled workforce, expected synergies and other intangible assets that do not qualify for separate recognition. All of the goodwill recognized was assigned to the Company's European segment.

Intangible assets consist primarily of amounts recognized for the fair value of customer relationship intangibles and patents. These amortizable intangible assets are being amortized on a straight-line basis over a 15 year estimated useful life.

Sales and net income for the acquired GETRAG entities for the year ended December 31, 2016 were \$2.0 billion and \$45 million, respectively.

The following table provides consolidated supplemental pro forma information as if the acquisition of GETRAG had occurred on January 1, 2015.

	December 31, 2015
Sales	\$ 34,150
Net income attributable to Magna International Inc.	\$ 1,992

The unaudited pro forma financial results do not include any anticipated synergies or other expected benefits of the acquisition. This information is presented for informational purposes only and is not indicative of future operating results.

Other

During the fourth quarter of 2016, the Company acquired 100% of the equity interest in the BÖCO Group of Companies ["BÖCO"]. BÖCO is an automotive supplier of latches, hinges and strikers, with sales primarily to the BMW Group, Daimler and Audi.

During the second quarter of 2016, the Company acquired 100% of the equity interest in Telemotive AG, an engineering service provider in the field of automotive electronics. The acquired business has sales primarily to BMW, Volkswagen and Daimler.

These entities have been included in our consolidated results of operations since their respective acquisition dates. Pro forma results of operations during the current period have not been presented because the effects of these acquisitions, individually and in aggregate, were not material to the Company's consolidated results of operations.

Acquisitions in the year ended December 31, 2015

On December 10, 2015, the Company entered into a partnership agreement in China [the "Xingqiaorui Partnership"] with Chongqing Xingqiaorui. Under the terms of the arrangement, Xingqiaorui transferred a 53% controlling interest in its three China manufacturing facilities and cash consideration of \$36 million. In exchange, the Company transferred a 47% non-controlling equity interest in its Chongqing manufacturing facility and cash consideration of \$130 million to Xingqiaorui. The acquisition of the 53% controlling interest in the China manufacturing facilities was accounted for as a business combination.

On November 30, 2015, the Company acquired a 100% interest in Stadco Automotive Ltd. ["Stadco"] for total cash consideration of \$115 million. Stadco, based in the United Kingdom, is a supplier of steel and aluminum stampings as well as vehicle assemblies primarily to Jaguar and Land Rover.

The final allocation of the consideration transferred to the assets acquired and liabilities assumed for both the Xingqiaorui Partnership and Stadco has been completed. As a result of additional information obtained, changes to the preliminary fair values of certain property, plant and equipment, definite-lived intangible assets and contingent tax liabilities, from the amounts disclosed as of December 31, 2015 were recorded during the three months ended December 31, 2016, resulting in a net adjustment to goodwill of \$14 million. These adjustments did not have a material impact on the Company's earnings in any period.

8. INVENTORIES

Inventories consist of:

	2016	2015
Raw materials and supplies	\$ 1,007	\$ 843
Work-in-process	264	246
Finished goods	327	311
Tooling and engineering	1,206	1,164
	\$ 2,804	\$ 2,564

Tooling and engineering inventory represents costs incurred on tooling and engineering services contracts in excess of billed and unbilled amounts included in accounts receivable.

9. INVESTMENTS IN AFFILIATED COMPANIES

The Company uses the equity method of accounting for its investments in entities over which it does not have control, but is able to exercise significant influence over operating and financial policies.

The ownership percentages and carrying value of the Company's principal equity method investments at December 31 were as follows [in millions, except percentages]:

		2016	2015
Litens Automotive Partnership ["Litens"] ^[i]	76.7%	\$ 173	\$ 138
GETRAG (Jiangxi) Transmission Co., Ltd	50.0%	\$ 1,015	\$ –
GETRAG Ford Transmission GmbH	50.0%	\$ 325	\$ –
Dongfeng GETRAG Transmission Co. Ltd ^[ii]	50.0%	\$ 79	\$ –

[i] Litens – The Company accounts for its investment in Litens under the equity method of accounting as a result of significant participating rights that prevent control.

[ii] DGT – DGT is a variable interest entity ["VIE"] and depends on the Company and the Dongfeng Motor Group Company for any additional cash needs. The Company cannot make key operating decisions considered to be most significant to the VIE, and is therefore not considered to be the primary beneficiary. Our known maximum exposure to loss approximated the carrying value of our investment balance as at December 31, 2016.

A summary of the total financial results, as reported by the Company's equity method investees, in the aggregate, at December 31 was as follows:

Summarized Balance Sheets

	2016	2015
Current assets	\$ 2,478	\$ 905
Non-current assets	\$ 4,450	\$ 756
Current liabilities	\$ 2,329	\$ 806
Long-term liabilities	\$ 1,268	\$ 335

Summarized Income Statements

	2016	2015
Sales	\$ 5,009	\$ 3,168
Cost of goods sold, expenses and income taxes	4,668	2,886
Net income	\$ 341	\$ 282

No impairment charges were recorded for the years ended December 31, 2016 and 2015. Sales to equity method investees were approximately \$214 million and \$98 million in 2016 and 2015 respectively.

Variable Interest Entities

The Company has determined that two of its investees acquired as part of the GETRAG acquisition are variable interest entities, in which the Company is the primary beneficiary and has the power to direct the activities that are considered most significant to the entities. As a result, the assets, liabilities, and results of operations of these variable interest entity are included in the Company's Consolidated Financial Statements. The Company's maximum exposure to any potential losses associated with these affiliated companies is limited to its investment, and was \$187 million at December 31, 2016.

The carrying amounts and classification of assets and liabilities included in the Company's consolidated balance sheet related to the consolidated VIEs are as follows:

	2016
Current assets	\$ 256
Noncurrent assets	221
Total assets	\$ 477
Current liabilities	\$ 288
Noncurrent liabilities	2
Total liabilities	\$ 290

Assets recognized as a result of consolidating these VIEs do not represent additional assets that could be used to satisfy claims against the Company's general assets. Conversely, liabilities recognized as a result of consolidating these VIEs do not represent additional claims on the Company's general assets; rather, they represent claims against the specific assets of the consolidated VIEs.

10. FIXED ASSETS

Fixed assets consist of:

	2016	2015
Cost		
Land	\$ 254	\$ 259
Buildings	1,942	1,659
Machinery and equipment	12,349	11,016
	14,545	12,934
Accumulated depreciation		
Buildings	(652)	(590)
Machinery and equipment	(6,871)	(6,396)
	\$ 7,022	\$ 5,948

Included in the cost of fixed assets are construction in progress expenditures of \$1.0 billion [2015 - \$1.3 billion] that have not been depreciated.

11. GOODWILL

The following is a continuity of the Company's goodwill by segment:

	North America	Europe	Asia	Total
Balance, December 31, 2014	\$ 633	\$ 577	\$ 127	\$ 1,337
Acquisitions <i>[note 7]</i>	-	13	107	120
Foreign exchange and other	(43)	(65)	(5)	(113)
Balance, December 31, 2015	590	525	229	1,344
Acquisitions <i>[note 7]</i>	-	620	(5)	615
Foreign exchange and other	5	(29)	(12)	(36)
Balance, December 31, 2016	\$ 595	\$ 1,116	\$ 212	\$ 1,923

12. INCOME TAXES

- [a] The provision for income taxes differs from the expense that would be obtained by applying the Canadian statutory income tax rate as a result of the following:

	2016	2015
Canadian statutory income tax rate	26.5%	26.5%
Manufacturing and processing profits deduction	(0.3)	(0.4)
Foreign rate differentials	(0.2)	0.8
Losses not benefited	0.8	1.1
Utilization of losses previously not benefited	(0.2)	(0.1)
Earnings of equity accounted investees	(1.2)	(0.8)
Tax on repatriation of foreign earnings	0.7	2.1
Valuation allowance on deferred tax assets [i]	(0.4)	–
Write off of investment [ii]	–	(1.4)
Research and development tax credits	(1.5)	(1.3)
Reserve for uncertain tax positions	0.2	(0.3)
Non-deductible foreign exchange losses [iii]	1.3	1.0
Others	(0.3)	(0.4)
Effective income tax rate	25.4%	26.8%

[i] GAAP requires that the Company assess whether valuation allowances should be established or maintained against its deferred tax assets, based on consideration of all available evidence, using a "more-likely-than-not" standard. The factors the Company uses to assess the likelihood of realization are its history of losses, forecasts of future pre-tax income and tax planning strategies that could be implemented to realize the deferred tax assets.

[ii] During 2015, the Company recorded a benefit related to the write-off of historical tax basis in one of its South American subsidiaries.

[iii] Non-deductible foreign exchange losses are related to the re-measurement of financial statement balances of foreign subsidiaries, primarily in Mexico, that are maintained in a currency other than their functional currency.

- [b] The details of income before income taxes by jurisdiction are as follows:

	2016	2015
Canadian	\$ 617	\$ 590
Foreign	2,163	2,061
	\$ 2,780	\$ 2,651

- [c] The details of the income tax provision are as follows:

	2016	2015
Current		
Canadian	\$ 127	\$ 140
Foreign	559	578
	686	718
Deferred		
Canadian	16	14
Foreign	4	(21)
	20	(7)
	\$ 706	\$ 711

[d] Deferred income taxes have been provided on temporary differences, which consist of the following:

	2016	2015
Tax depreciation greater than book depreciation	\$ 58	\$ 12
Book amortization (in excess of) less than tax amortization	(41)	7
Liabilities currently not deductible for tax	48	-
Net tax losses benefited	(31)	(13)
Change in valuation allowance on deferred tax assets	(12)	(1)
Tax on undistributed foreign earnings	8	3
Others	(10)	(15)
	\$ 20	\$ (7)

[e] Deferred tax assets and liabilities consist of the following temporary differences:

	2016	2015
Assets		
Tax benefit of loss carryforwards	\$ 715	\$ 614
Liabilities currently not deductible for tax	106	211
Tax credit carryforwards	22	24
Unrealized loss on cash flow hedges and retirement liabilities	134	154
Other assets tax value in excess of book values	36	11
Others	21	5
	1,034	1,019
Valuation allowance against tax benefit of loss carryforwards	(615)	(562)
Other valuation allowance	(66)	(50)
	353	407
Liabilities		
Tax depreciation in excess of book depreciation	277	249
Tax on undistributed foreign earnings	98	10
Unrealized gain on cash flow hedges and retirement liabilities	3	9
	378	268
Net deferred tax (liabilities) assets	\$ (25)	\$ 139

The net deferred tax (liabilities) assets are presented on the consolidated balance sheet in the following categories:

	2016	2015
Long-term deferred tax assets	\$ 268	\$ 271
Long-term deferred tax liabilities	(293)	(132)
	\$ (25)	\$ 139

[f] The Company has provided for deferred income taxes for the estimated tax cost of distributable earnings of its subsidiaries. Deferred income taxes have not been provided on approximately \$4.46 billion of undistributed earnings of certain foreign subsidiaries, as the Company has concluded that such earnings should not give rise to additional tax liabilities upon repatriation or are indefinitely reinvested. A determination of the amount of the unrecognized tax liability relating to the remittance of such undistributed earnings is not practicable.

[g] Income taxes paid in cash [net of refunds] were \$707 million for the year ended December 31, 2016 [2015 - \$647 million].

[h] As of December 31, 2016, the Company had domestic and foreign operating loss carryforwards of \$2.29 billion and tax credit carryforwards of \$22 million. Approximately \$1.65 billion of the operating losses can be carried forward indefinitely. The remaining operating losses and tax credit carryforwards expire between 2017 and 2036.

- [i] As at December 31, 2016 and 2015, the Company's gross unrecognized tax benefits were \$220 and \$221 million, respectively [excluding interest and penalties], of which \$201 and \$158 million, respectively, if recognized, would affect the Company's effective tax rate. The gross unrecognized tax benefits differ from the amount that would affect the Company's effective tax rate due primarily to the impact of the valuation allowance on deferred tax assets. A summary of the changes in gross unrecognized tax benefits is as follows:

	2016	2015
Balance, beginning of year	\$ 221	\$ 202
Increase based on tax positions related to current year	21	17
(Decrease) increase based on tax positions of prior years	(52)	53
Increase related to business acquisitions	44	–
Settlements	(2)	(15)
Statute expirations	(8)	(20)
Foreign currency translation	(4)	(16)
	\$ 220	\$ 221

The Company recognizes interest and penalties with respect to unrecognized tax benefits as income tax expense. As at December 31, 2016 and 2015, the Company had recorded interest and penalties on the unrecognized tax benefits of \$35 and \$21 million, respectively, which reflects expenses related to changes in its reserves for interest and penalties of \$14 and \$3 million, respectively.

The Company operates in multiple jurisdictions throughout the world, and its tax returns are periodically audited or subject to review by both domestic and foreign tax authorities. During the next twelve months, it is reasonably possible that, as a result of audit settlements, the conclusion of current examinations and the expiration of the statute of limitations in several jurisdictions, the Company may decrease the amount of its gross unrecognized tax benefits [including interest and penalties] by approximately \$62 million, of which \$52 million, if recognized, would affect its effective tax rate.

The Company considers its significant tax jurisdictions to include Canada, the United States, Austria, Germany and Mexico. With few exceptions, the Company remains subject to income tax examination in Germany for years after 2007, in Austria for years after 2008, Mexico for years after 2010, and in Canada and the U.S. federal jurisdiction for years after 2012.

13. INTANGIBLE ASSETS

Intangible assets were as follows:

	Estimated weighted average useful life in years	2016	2015
Cost			
Customer relationship intangibles <i>[note 7]</i>	12	\$ 392	\$ 134
Computer software	4	316	278
Patent and licenses	15	278	39
		986	451
Accumulated depreciation			
Customer relationship intangibles <i>[note 7]</i>		(96)	(53)
Computer software		(242)	(221)
Patent and licenses		(27)	(8)
		\$ 621	\$ 169

The Company recorded approximately \$100 million and \$48 million of amortization expense related to definite-lived intangible assets for the years ended December 31, 2016 and 2015, respectively. The Company currently estimates annual amortization expense to be \$90 million for 2017, \$82 million for 2018, \$66 million for 2019, \$47 million for 2020 and \$44 million for 2021.

14. OTHER ASSETS

Other assets consist of:

	2016	2015
Preproduction costs related to long-term supply agreements		
with contractual guarantee for reimbursement	\$ 420	\$ 276
Long-term receivables [note 22(c)]	229	87
Pension overfunded status [note 18(a)]	21	17
Unrealized gain on cash flow hedges [note 22]	6	5
Other, net	43	27
	\$ 719	\$ 412

15. EMPLOYEE EQUITY AND PROFIT PARTICIPATION PROGRAM

During the year ended December 31, 2016, a trust, which exists to make orderly purchases of the Company's shares for employees for transfer to the Employee Equity and Profit Participation Program ["EPPPP"], borrowed up to \$10 million [2015 - \$55 million] from the Company to facilitate the purchase of Common Shares. At December 31, 2016, the trust's indebtedness to Magna was \$10 million [2015 - \$5 million]. The Company nets the receivable from the trust with the Company's accrued EPPPP payable in accrued wages and salaries.

16. WARRANTY

The following is a continuity of the Company's warranty accruals:

	2016	2015
Balance, beginning of year	\$ 59	\$ 80
Expense, net	101	26
Settlements	(59)	(53)
Acquisitions [i]	174	–
Foreign exchange and other	(5)	6
	\$ 270	\$ 59

[i] \$127 million of the acquisition balance relates to a pre-acquisition settlement agreement negotiated with a customer and a supplier for a specific performance issue [note 7].

17. DEBT

Short-term borrowings

The Company's short-term borrowings consist of the following:

	2016	2015
Bank indebtedness [i]	\$ 8	\$ 25
Commercial paper [ii]	615	–
	\$ 623	\$ 25

[i] In the third quarter of 2016, the Company entered into an agreement for a credit facility that is drawn in euros. The Company is required to secure any amounts drawn on the facility with a USD cash deposit of 105% of the outstanding euro balance. As of December 31, 2016, the gross amount outstanding under the credit facility was \$185 million [€175 million]. The credit agreement includes a netting arrangement with the bank that provides for the legal right of setoff. Accordingly, as at December 31, 2016, this liability balance was offset against the related restricted cash deposit of \$194 million. The remaining net cash deposit of \$9 million was included in the prepaid expenses and other balance, and is restricted under the terms of the loan.

[ii] During 2016, the Company established a U.S. commercial paper program [the "U.S. Program"] and a euro-commercial paper program [the "euro-Program"]. Under the U.S. Program, the Company may issue U.S. commercial paper notes [the "U.S. notes"] up to a maximum aggregate amount of U.S. \$500 million. The U.S. Program is supported by the Company's existing global credit facility. The proceeds from the issuance of the U.S. notes are being used for general corporate purposes. As at December 31, 2016, \$295 million of U.S. notes were outstanding, with a weighted-average interest rate of 1.04%, and maturities generally less than three months.

Under the euro-Program, the Company may issue euro-commercial paper notes [the "euro notes"] up to a maximum aggregate amount of €500 million or its equivalent in alternative currencies. The euro notes issued are being guaranteed by the Company's existing global credit facility. The proceeds from the issuance of the euro notes are being used for general corporate purposes. As of December 31, 2016, \$320 million [€304 million] of euro notes were outstanding, with a negative weighted-average interest rate of 0.07%, and maturities generally less than three months.

Long-term borrowings

[a] The Company's long-term debt, which is substantially uncollateralized, consists of the following:

	2016	2015
Senior Notes <i>[note 17 [c]]</i>		
\$750 million Senior Notes due 2024 at 3.625%	\$ 746	\$ 745
\$650 million Senior Notes due 2025 at 4.150%	643	643
€550 million Senior Notes due 2023 at 1.900%	576	592
Cdn\$425 million Senior Notes due 2022 at 3.100%	315	305
Bank term debt at a weighted average interest rate of approximately 7.3% [2015 - 8.1%], denominated primarily in Indian rupee, Chinese renminbi, euro and Brazilian real	117	202
Government loans at a weighted average interest rate of approximately 2.53% [2015 - 3.7%], denominated primarily in euro, Canadian dollar and Brazilian real	92	9
Other	44	42
	2,533	2,538
Less due within one year	139	211
	\$ 2,394	\$ 2,327

[b] Future principal repayments on long-term debt are estimated to be as follows:

2017	\$ 139
2018	39
2019	26
2020	22
2021	20
Thereafter	2,287
	\$ 2,533

[c] All of the Senior Notes pay a fixed rate of interest semi-annually except for the €550 million Senior Notes which pay a fixed rate of interest annually. The Senior Notes are unsecured obligations and do not include any financial covenants. The Company may redeem the Senior Notes in whole or in part at any time, at specified redemption prices determined in accordance with the terms of each of the respective indentures governing the Senior Notes. All of the Senior Notes were issued for general corporate purposes.

[d] The Company's \$2.75 billion revolving credit facility matures on June 22, 2021. The facility includes a \$200 million Asian tranche, a \$100 million Mexican tranche and a tranche for Canada, U.S. and Europe, which is fully transferable between jurisdictions and can be drawn in U.S. dollars, Canadian dollars or euros.

[e] Interest expense, net includes:

	2016	2015
Interest expense		
Current	\$ 22	\$ 20
Long-term	78	38
	100	58
Interest income	(12)	(14)
Interest expense, net	\$ 88	\$ 44

[f] Interest paid in cash was \$99 million for the year ended December 31, 2016 [2015 - \$54 million].

[g] At December 31, 2016, the Company had commitments under operating leases requiring annual rental payments as follows:

	Total
2017	\$ 277
2018	237
2019	208
2020	183
2021	164
Thereafter	586
	\$ 1,655

For the year ended December 31, 2016, operating lease expense was \$314 million [2015 - \$285 million].

18. LONG-TERM EMPLOYEE BENEFIT LIABILITIES

Long-term employee benefit liabilities consist of:

	2016	2015
Defined benefit pension plans and other [a]	\$ 313	\$ 181
Termination and long service arrangements [b]	319	287
Retirement medical benefits plans [c]	29	30
Other long-term employee benefits	6	6
Long-term employee benefit obligations	\$ 667	\$ 504

[a] Defined benefit pension plans

The Company sponsors a number of defined benefit pension plans and similar arrangements for its employees. All pension plans are funded to at least the minimum legal funding requirements, while European defined benefit pension plans are unfunded.

The weighted average significant actuarial assumptions adopted in measuring the Company's obligations and costs are as follows:

	2016	2015
Projected benefit obligation		
Discount rate	3.1%	3.8%
Rate of compensation increase	2.3%	2.5%
Net periodic benefit cost		
Discount rate	3.2%	3.7%
Rate of compensation increase	2.4%	2.7%
Expected return on plan assets	5.8%	5.9%

Information about the Company's defined benefit pension plans is as follows:

	2016	2015
Projected benefit obligation		
Beginning of year	\$ 493	\$ 536
Current service cost	14	12
Interest cost	21	18
Actuarial losses (gains) and changes in actuarial assumptions	28	(18)
Benefits paid	(22)	(18)
Benefits paid – settlements [i]	(32)	–
Acquisition	129	1
Gain on settlement	(5)	–
Foreign exchange	(2)	(38)
End of year	624	493
Plan assets at fair value [ii]		
Beginning of year	326	347
Return on plan assets	22	7
Employer contributions	19	19
Benefits paid	(17)	(18)
Benefits paid – settlements [i]	(32)	–
Acquisition	8	–
Foreign exchange	4	(29)
End of year	330	326
Ending funded status	\$ 294	\$ 167

	2016	2015
Amounts recorded in the consolidated balance sheet		
Non-current asset <i>[note 14]</i>	\$ (21)	\$ (17)
Current liability	2	3
Non-current liability	313	181
Net amount	\$ 294	\$ 167
Amounts recorded in accumulated other comprehensive income		
Unrecognized actuarial losses	\$ (144)	\$ (138)
Net periodic benefit cost		
Current service cost	\$ 14	\$ 12
Interest cost	21	18
Return on plan assets	(20)	(20)
Benefits paid – settlements [i]	13	–
Actuarial losses	3	4
Net periodic benefit cost	\$ 31	\$ 14

[i] During the fourth quarter of 2016, the Company offered a limited lump-sum payout to certain terminated vested plan participants on its U.S. defined benefit pension plan. Under this offer, certain participants were able to voluntarily elect an early payout of their pension benefits, in the form of a lump-sum payment. The lump-sum payment was equal to the present value of the participant's pension benefits. In connection with the partial settlement, payments of \$32 million were distributed from existing defined benefit pension plan assets, and the Company recognized a \$13 million non-cash settlement charge *[note 4]*.

[ii] The asset allocation of the Company's defined benefit pension plans at December 31, 2016 and the target allocation for 2017 is as follows:

	2017	2016
Equity securities	55-75%	61%
Fixed income securities	25-45%	39%
Cash and cash equivalents	0-15%	0%
	100%	100%

Substantially all of the plan assets' fair value has been determined using significant observable inputs [level 2] from indirect market prices on regulated financial exchanges.

The expected rate of return on plan assets was determined by considering the Company's current investment mix, the historic performance of these investment categories and expected future performance of these investment categories.

[b] Termination and long service arrangements

Pursuant to labour laws and national labour agreements in certain European countries and Mexico, the Company is obligated to provide lump sum termination payments to employees on retirement or involuntary termination, and long service payments contingent upon persons reaching a predefined number of years of service.

The weighted average significant actuarial assumptions adopted in measuring the Company's projected termination and long service benefit obligations and net periodic benefit cost are as follows:

	2016	2015
Discount rate	2.9%	3.1%
Rate of compensation increase	2.7%	2.8%

Information about the Company's termination and long service arrangements is as follows:

	2016	2015
Projected benefit obligation		
Beginning of year	\$ 295	\$ 323
Current service cost	20	15
Interest cost	8	8
Actuarial losses and changes in actuarial assumptions	15	2
Benefits paid	(11)	(12)
Acquisition	16	-
Divestiture	-	(4)
Foreign exchange	(16)	(37)
Ending funded status	\$ 327	\$ 295
Amounts recorded in the consolidated balance sheet		
Current liability	\$ 8	\$ 8
Non-current liability	319	287
Net amount	\$ 327	\$ 295
Amounts recorded in accumulated other comprehensive income		
Unrecognized actuarial losses	\$ (84)	\$ (69)
Net periodic benefit cost		
Current service cost	\$ 20	\$ 15
Interest cost	8	8
Actuarial losses	1	18
Net periodic benefit cost	\$ 29	\$ 41

[c] Retirement medical benefits plans

The Company sponsors a number of retirement medical plans which were assumed on certain acquisitions in prior years. These plans are frozen to new employees and incur no current service costs.

In addition, the Company sponsors a retirement medical benefits plan that was amended during 2009 such that substantially all employees retiring on or after August 1, 2009 no longer participate in the plan.

The weighted average discount rates used in measuring the Company's projected retirement medical benefit obligations and net periodic benefit cost are as follows:

	2016	2015
Retirement medical benefit obligations	3.8%	3.9%
Net periodic benefit cost	3.9%	3.7%
Health care cost inflation	7.0%	6.5%

Information about the Company's retirement medical benefits plans are as follows:

	2016	2015
Projected benefit obligation		
Beginning of year	\$ 32	\$ 41
Interest cost	1	1
Actuarial gains and changes in actuarial assumptions	(1)	(7)
Benefits paid	(1)	(2)
Foreign exchange	-	(1)
Ending funded status	\$ 31	\$ 32
Amounts recorded in the consolidated balance sheet		
Current liability	\$ 2	\$ 2
Non-current liability	29	30
Net amount	\$ 31	\$ 32
Amounts recorded in accumulated other comprehensive income		
Unrecognized past service costs	\$ 1	\$ 1
Unrecognized actuarial gains	11	11
Total accumulated other comprehensive income	\$ 12	\$ 12
Net periodic benefit cost		
Interest cost	\$ 1	\$ 2
Past service cost amortization	(1)	(1)
Net periodic benefit cost	\$ -	\$ 1

The effect of a one-percentage point increase or decrease in health care trend rates would not have a significant impact on the Company's income.

[d] Future benefit payments

	Defined benefit pension plans	Termination and long service arrangements	Retirement medical benefits plans	Total
Expected employer contributions - 2017	\$ 24	\$ 8	\$ 2	\$ 34
Expected benefit payments:				
2017	\$ 21	\$ 8	\$ 2	\$ 31
2018	21	9	2	32
2019	21	11	2	34
2020	23	13	2	38
2021	23	15	2	40
Thereafter	133	91	9	233
	\$ 242	\$ 147	\$ 19	\$ 408

19. OTHER LONG-TERM LIABILITIES

Other long-term liabilities consist of:

	2016	2015
Long-term portion of fair value of hedges <i>[note 22]</i>	\$ 61	\$ 152
Long-term portion of income taxes payable	181	131
Asset retirement obligation	28	26
Long-term lease inducements	16	19
Deferred revenue	12	3
	\$ 298	\$ 331

20. CAPITAL STOCK

[a] At December 31, 2016, the Company's authorized, issued and outstanding capital stock are as follows:

Preference shares - issuable in series -

The Company's authorized capital stock includes 99,760,000 preference shares, issuable in series. None of these shares are currently issued or outstanding.

Common Shares -

Common Shares without par value [unlimited amount authorized] have the following attributes:

- [i] Each share is entitled to one vote per share at all meetings of shareholders.
 - [ii] Each share shall participate equally as to dividends.
- [b] On November 10, 2016, the TSX accepted the Company's Notice of Intention to Make a Normal Course Issuer Bid relating to the purchase for cancellation, as well as purchases to fund the Company's stock-based compensation awards or programs and/or the Company's obligations to its deferred profit sharing plans, of up to 38 million Magna Common Shares [the "2016 Bid"], representing approximately 10% of the Company's public float of Common Shares. The Bid commenced on November 15, 2016 and will terminate no later than November 17, 2017.

Previously, the Company had Normal Course Issuer Bids in place for the 12 month periods beginning in November 2015 and 2014.

The following is a summary of the Normal Course Issuer Bids [number of shares in the table below are expressed in whole numbers]:

	Maximum number of shares	2016		2015	
		Shares purchased	Cash amount	Shares purchased	Cash amount
2014 Bid	40,000,000	-	\$ -	8,166,514	\$ 388
2015 Bid	40,000,000	20,313,194	818	2,585,970	113
2016 Bid	38,000,000	2,021,824	86	-	-
		22,335,018	\$ 904	10,752,484	\$ 501

Certain purchases were made by way of private agreements entered into with arm's length, third party sellers. Such private agreement purchases were made at a discount to the prevailing market price for the Company's Common Shares and pursuant to issuer bid exemption orders issued by the Ontario Securities Commission. All other purchases of Common Shares are made at the market price at the time of purchase in accordance with the rules and policies of the TSX. Purchases may also be made on the NYSE in compliance with Rule 10b-18 under the U.S. Securities Exchange Act of 1934.

[c] The following table presents the maximum number of shares that would be outstanding if all the dilutive instruments outstanding at March 9, 2017 were exercised or converted:

Common Shares	382,269,005
Stock options	9,258,413
	391,527,418

21. ACCUMULATED OTHER COMPREHENSIVE LOSS

The following is a continuity schedule of accumulated other comprehensive loss:

	2016	2015
Accumulated net unrealized loss on translation of net investment in foreign operations		
Balance, beginning of year	\$ (1,042)	\$ (255)
Net unrealized loss	(109)	(798)
Repurchase of shares under normal course issuer bids <i>[note 20]</i>	20	11
Balance, end of year	(1,131)	(1,042)
Accumulated net unrealized loss on cash flow hedges [b]		
Balance, beginning of year	(262)	(113)
Net unrealized gain (loss)	1	(244)
Reclassification of net loss to net income [a]	126	95
Balance, end of year	(135)	(262)
Accumulated net unrealized loss on other long-term liabilities [b]		
Balance, beginning of year	(165)	(186)
Net unrealized (loss) gain	(29)	14
Reclassification of net loss to net income [a]	9	7
Balance, end of year	(185)	(165)
Accumulated net unrealized loss on available-for-sale investments		
Balance, beginning of year	(1)	(4)
Net unrealized loss	-	3
Reclassification of net loss to net income [a]	1	-
Balance, end of year	-	(1)
Total accumulated other comprehensive loss [c]	\$ (1,451)	\$ (1,470)

[a] The effects on net income of amounts reclassified from AOCL, with presentation location, were as follows:

	2016	2015
Cash flow hedges		
Sales	\$ (87)	\$ (86)
Cost of sales	(87)	(45)
Interest	-	(3)
Income tax	48	39
Net of tax	(126)	(95)
Other long-term liabilities		
Cost of sales	1	(9)
Income tax	-	2
Net of tax	1	(7)
Total loss reclassified to net income	\$ (125)	\$ (102)

[b] The amount of income tax benefit that has been allocated to each component of other comprehensive loss is as follows:

	2016	2015
Accumulated net unrealized loss on cash flow hedges		
Balance, beginning of year	\$ 97	\$ 44
Net unrealized loss	4	92
Reclassification of net loss to net income	(48)	(39)
Balance, end of year	53	97
Accumulated net unrealized loss on other long-term liabilities		
Balance, beginning of year	31	36
Net unrealized loss (gain)	3	(3)
Reclassification of net loss to net income	(4)	(2)
Balance, end of year	30	31
Total income tax benefit	\$ 83	\$ 128

[c] The amount of other comprehensive loss that is expected to be reclassified to net income during 2017 is \$130 million.

22. FINANCIAL INSTRUMENTS

[a] Foreign exchange contracts

At December 31, 2016, the Company had outstanding foreign exchange forward contracts representing commitments to buy and sell various foreign currencies. Significant commitments are as follows:

Buy (Sell)	For Canadian dollars				For U.S. dollars	
	U.S. dollar amount	Weighted average rate	Euro amount	Weighted average rate	Peso amount	Weighted average rate
2017	122	1.32036	23	1.45496	3,500	0.05995
2017	(885)	0.79352	(15)	0.68983	–	–
2018	1	1.30509	1	1.44050	1,819	0.05194
2018	(597)	0.78550	(2)	0.68689	–	–
2019	–	–	–	–	564	0.04335
2019	(338)	0.78407	–	–	–	–
2020	(126)	0.76519	–	–	–	–
2021	(8)	0.76001	–	–	–	–
	(1,831)		7		5,883	

Buy (Sell)	For euros					
	U.S. dollar amount	Weighted average rate	GBP amount	Weighted average rate	Czech koruna amount	Weighted average rate
2017	115	0.90038	5	1.18435	4,084	0.03722
2017	(112)	1.19637	(28)	0.84126	–	–
2018	43	0.87976	1	1.17412	2,389	0.03766
2018	(53)	1.16833	(17)	0.80446	–	–
2019	24	0.86787	–	–	1,167	0.03777
2019	(24)	1.15362	(9)	0.80790	–	–
2020	5	0.86156	–	–	165	0.03802
2020	(2)	1.17400	(5)	0.87553	–	–
	(4)		(53)		7,805	

Based on forward foreign exchange rates as at December 31, 2016 for contracts with similar remaining terms to maturity, the gains and losses relating to the Company's foreign exchange forward contracts recognized in other comprehensive income are approximately \$18 million and \$195 million, respectively [note 21].

The Company does not enter into foreign exchange forward contracts for speculative purposes.

[b] Financial assets and liabilities

The Company's financial assets and liabilities consist of the following:

	2016	2015
Trading		
Cash and cash equivalents	\$ 974	\$ 2,863
Investment in ABCP	60	73
Equity investments	-	4
	\$ 1,034	\$ 2,940
Held-to-maturity investments		
Severance investments	\$ 3	\$ 3
Loans and receivables		
Accounts receivable	\$ 6,165	\$ 5,439
Long-term receivables included in other assets <i>[note 14]</i>	229	87
	\$ 6,394	\$ 5,526
Other financial liabilities		
Bank indebtedness	\$ 8	\$ 25
Commercial paper	615	-
Long-term debt (including portion due within one year)	2,533	2,538
Accounts payable	5,430	4,746
	\$ 8,586	\$ 7,309
Derivatives designated as effective hedges, measured at fair value		
Foreign currency contracts		
Prepaid expenses and other	\$ 12	\$ 27
Other assets	6	4
Other accrued liabilities	(134)	(191)
Other long-term liabilities	(61)	(152)
	\$ (177)	\$ (312)

[c] Derivatives designated as effective hedges, measured at fair value

The Company presents derivatives that are designated as effective hedges at gross fair values in the consolidated balance sheets. However, master netting and other similar arrangements allow net settlements under certain conditions. The following table shows the Company's derivative foreign currency contracts at gross fair value as reflected in the consolidated balance sheets and the unrecognized impacts of master netting arrangements:

	Gross amounts presented in consolidated balance sheets	Gross amounts not offset in consolidated balance sheets	Net amounts
December 31, 2016			
Assets	\$ 18	\$ 17	\$ 1
Liabilities	\$ (195)	\$ (17)	\$ (178)
December 31, 2015			
Assets	\$ 31	\$ 30	\$ 1
Liabilities	\$ (343)	\$ (30)	\$ (313)

[d] Fair value

The Company determined the estimated fair values of its financial instruments based on valuation methodologies it believes are appropriate; however, considerable judgment is required to develop these estimates. Accordingly, these estimated fair values are not necessarily indicative of the amounts the Company could realize in a current market exchange. The estimated fair value amounts can be materially affected by the use of different assumptions or methodologies. The methods and assumptions used to estimate the fair value of financial instruments are described below:

Cash and cash equivalents, accounts receivable, bank indebtedness and accounts payable

Due to the short period to maturity of the instruments, the carrying values as presented in the consolidated balance sheets are reasonable estimates of fair values.

Investments

At December 31, 2016, the Company held Canadian third party ABCP with a face value of Cdn\$81 million [2015 - Cdn\$107 million]. The investment had a carrying value of Cdn\$81 million [December 31, 2015 - Cdn\$101 million]. At December 31, 2016, the fair value of the ABCP was Cdn\$81 million based on its maturity value in January 2017.

Commercial Paper

Due to the short period to maturity of the commercial paper, the carrying value as presented in the consolidated balance sheet is a reasonable estimate of its fair value.

Term debt

The Company's term debt includes \$139 million due within one year. Due to the short period to maturity of this debt, the carrying value as presented in the consolidated balance sheet is a reasonable estimate of its fair value.

Senior Notes

The fair value of our Senior Notes are classified as Level 1 when we use quoted prices in active markets and Level 2 when the quoted prices are from less active markets or when other observable inputs are used to determine fair value. At December 31, 2016, the net book value of the Company's Senior Notes was \$2.30 billion and the estimated fair value was \$2.36 billion, determined primarily using active market prices.

[e] Credit risk

The Company's financial assets that are exposed to credit risk consist primarily of cash and cash equivalents, accounts receivable, held-to-maturity investments and foreign exchange and commodity forward contracts with positive fair values.

Cash and cash equivalents, which consist of short-term investments, are only invested in governments, bank term deposits and bank commercial paper with an investment grade credit rating. Credit risk is further reduced by limiting the amount which is invested in certain governments or any major financial institution.

The Company is also exposed to credit risk from the potential default by any of its counterparties on its foreign exchange forward contracts. The Company mitigates this credit risk by dealing with counterparties who are major financial institutions that the Company anticipates will satisfy their obligations under the contracts.

In the normal course of business, the Company is exposed to credit risk from its customers, substantially all of which are in the automotive industry and are subject to credit risks associated with the automotive industry. For the year ended December 31, 2016, sales to the Company's six largest customers represented 82% [2015 - 83%] of the Company's total sales; and substantially all of its sales are to customers in which the Company has ongoing contractual relationships.

[f] Currency risk

The Company is exposed to fluctuations in foreign exchange rates when manufacturing facilities have committed to the delivery of products for which the selling price has been quoted in currencies other than the facilities' functional currency, and when materials and equipment are purchased in currencies other than the facilities' functional currency. In an effort to manage this net foreign exchange exposure, the Company employs hedging programs, primarily through the use of foreign exchange forward contracts [note 22[a]].

[g] Interest rate risk

The Company is not exposed to significant interest rate risk due to the short-term maturity of its monetary current assets and current liabilities. In particular, the amount of interest income earned on cash and cash equivalents is impacted more by investment decisions made and the demands to have available cash on hand, than by movements in interest rates over a given period.

In addition, the Company is not exposed to interest rate risk on its term debt and Senior Notes as the interest rates on these instruments are fixed.

23. CONTINGENCIES

From time to time, the Company may become involved in regulatory proceedings, or become liable for legal, contractual and other claims by various parties, including customers, suppliers, former employees, class action plaintiffs and others. On an ongoing basis, the Company attempts to assess the likelihood of any adverse judgments or outcomes to these proceedings or claims, together with potential ranges of probable costs and losses. A determination of the provision required, if any, for these contingencies is made after analysis of each individual issue. The required provision may change in the future due to new developments in each matter or changes in approach such as a change in settlement strategy in dealing with these matters.

[a] In November 1997, the Company and two of its subsidiaries were sued by KS Centoco Ltd., an Ontario-based steering wheel manufacturer in which the Company has a 23% equity interest, and by Centoco Holdings Limited, the owner of the remaining 77% equity interest in KS Centoco Ltd. In March 1999, the plaintiffs were granted leave to make substantial amendments to the original statement of claim in order to add several new defendants and claim additional remedies and, in February 2006, the plaintiffs further amended their claim to add an additional remedy. In February 2016, a consent order was granted allowing the Plaintiffs to file a fresh statement of claim which includes an additional remedy and reduces certain aggravated and punitive damages claimed [the "Main Action"]. The fresh statement of claim alleges, among other things:

- breach of fiduciary duty by the Company and two of its subsidiaries;
- breach by the Company of its binding letter of intent with KS Centoco Ltd., including its covenant not to have any interest, directly or indirectly, in any entity that carries on the airbag business in North America, other than through MST Automotive Inc., a company to be 77% owned by Magna and 23% owned by Centoco Holdings Limited;
- the plaintiff's exclusive entitlement to certain airbag technologies in North America pursuant to an exclusive licence agreement [the "Licence Agreement"], together with an accounting of all revenues and profits resulting from the alleged use by the Company, TRW Inc. ["TRW"] and other unrelated third party automotive supplier defendants of such technology in North America;
- inducement by the Company of a breach of the Licence Agreement by TRW;
- a conspiracy by the Company, TRW and others to deprive KS Centoco Ltd. of the benefits of such airbag technology in North America and to cause Centoco Holdings Limited to sell to TRW its interest in KS Centoco Ltd. in conjunction with the Company's sale to TRW of its interest in MST Automotive GmbH and TEMIC Bayern-Chemie Airbag GmbH; and
- oppression by the defendants.

The plaintiffs are seeking, among other things, damages of approximately Cdn\$2.56 billion in the Main Action. Document production, completion of undertakings and examinations for discovery are substantially complete, although limited additional examinations for discovery are expected to occur.

In April 2016, the Company filed a new claim against Centoco Holdings Limited and KS Centoco Ltd. seeking an order under the Ontario *Business Corporations Act* to wind-up the business and affairs of KS Centoco Ltd. and distribute its assets to the shareholders [the "Wind-Up Action"]. In June 2016, Centoco Holdings Limited and KS Centoco Ltd. filed a statement of defence and counterclaim in the Wind-Up Action alleging breach of fiduciary duty and bad faith performance of contractual obligations by the Company and two of its officers who were the Company's representatives on KS Centoco Ltd.'s Board of Directors for a number of years [the "Centoco Counterclaim"]. Pursuant to the Centoco Counterclaim, Centoco Holdings Limited and KS Centoco Ltd. are claiming damages of approximately Cdn\$1.8 billion.

Both actions will be tried together at a trial scheduled to commence on October 30, 2017. The claims and damages in the Centoco Counterclaim substantially duplicate those described in the Main Action and, as a result, the Company believes that there is no incremental liability due to the Centoco Counterclaim. The Company also believes it has valid defences to the claims made by Centoco Holdings Limited and KS Centoco Ltd. in both actions and therefore intends to continue to vigorously defend these two cases. Due to the nature of the claims made and potential damages alleged by Centoco Holdings Limited and KS Centoco Ltd., the Company is unable to predict the final outcome of these claims.

- [b] In September 2014, the Conselho Administrativo de Defesa Economica, Brazil's Federal competition authority, attended at one of the Company's operating divisions in Brazil to obtain information in connection with an ongoing antitrust investigation relating to suppliers of automotive door latches and related products.

Proceedings of this nature can often continue for several years. Where wrongful conduct is found, the relevant antitrust authority can, depending on the jurisdiction, initiate administrative or criminal legal proceedings and impose administrative or criminal fines or penalties taking into account several mitigating and aggravating factors. At this time, management is unable to predict the duration or outcome of the Brazilian investigation, including whether any operating divisions of the Company will be found liable for any violation of law or the extent or magnitude of any liability, if found to be liable.

The Company's policy is to comply with all applicable laws, including antitrust and competition laws. The Company previously initiated a global review focused on antitrust risk led by a team of external counsel. If any antitrust violation is found as a result of such review, a regulatory investigation or otherwise, Magna could be subject to fines, penalties, restitution settlements and civil, administrative or criminal legal proceedings and other consequences, including reputational damage.

- [c] In certain circumstances, the Company is at risk for warranty costs including product liability and recall costs. Due to the nature of the costs, the Company makes its best estimate of the expected future costs [note 16]; however, the ultimate amount of such costs could be materially different. The Company continues to experience increased customer pressure to assume greater warranty responsibility. Currently, under most customer agreements, the Company only accounts for existing or probable claims. Under certain complete vehicle engineering and assembly contracts, and with respect to our powertrain systems programs, the Company records an estimate of future warranty-related costs based on the terms of the specific customer agreements, and the specific customer's [or the Company's] warranty experience.

24. SEGMENTED INFORMATION

- [a] Magna is a global automotive supplier which has complete vehicle engineering and contract manufacturing expertise, as well as product capabilities which include body, chassis, exterior, seating, powertrain, active driver assistance, vision, closure and roof systems. Magna has electronic and software capabilities across many of these areas.

Magna's success is directly dependent upon the levels of North American and European [and currently to a lesser extent on Asia and Rest of World] car and light truck production by its customers. OEM production volumes in each of North America and Europe may be impacted by a number of geographic factors, including general economic conditions, interest rates, consumer credit availability, fuel prices and availability, infrastructure, legislative changes, environmental emission and safety issues, and labour and/or trade relations.

Given the differences between the regions in which the Company operates, Magna's operations are segmented on a geographic basis. The Company's segments consist of North America, Europe, Asia and Rest of World. The Company maintains management teams in each of the Company's two primary markets, North America and Europe. The role of the North American and European management teams is to manage Magna's interests to ensure a coordinated effort across the Company's different product capabilities. In addition to maintaining key customer, supplier and government contacts in their respective markets, the regional management teams centrally manage key aspects of the Company's operations while permitting the divisions enough flexibility through Magna's decentralized structure to foster an entrepreneurial environment.

Consistent with the above, the Company's internal financial reporting separately segments key internal operating performance measures between North America, Europe, Asia and Rest of World for purposes of presentation to the chief operating decision maker to assist in the assessment of operating performance, the allocation of resources, and the long-term strategic direction and future global growth in the Company.

The Company's chief operating decision maker uses Adjusted EBIT as the measure of segment profit or loss, since management believes Adjusted EBIT is the most appropriate measure of operational profitability or loss for its reporting segments. Adjusted EBIT is calculated by taking net income from continuing operations and adding back income taxes, interest expense, net, and other expense (income), net.

The accounting policies of each segment are the same as those set out under "Significant Accounting Policies" [note 1] and intersegment sales and transfers are accounted for at fair market value.

The following tables show certain information with respect to segment disclosures:

2016							
	Total sales	External sales	Depreciation and amortization	Adjusted EBIT (ii)	Goodwill	Fixed asset additions	Fixed assets, net
North America							
Canada	\$ 6,784	\$ 6,214				\$ 201	\$ 721
United States	10,226	9,857				400	1,573
Mexico	5,121	4,586				309	999
Eliminations	(1,387)	–				–	–
North America	20,744	20,657	\$ 486	\$ 2,061	\$ 595	910	3,293
Europe							
Western Europe (excluding Great Britain)	10,537	10,159				578	1,912
Great Britain	658	656				24	127
Eastern Europe	2,285	2,000				136	545
Eliminations	(400)	–				–	–
Europe	13,080	12,815	431	543	1,116	738	2,584
Asia	2,674	2,502	103	266	212	97	679
Rest of World	465	464	13	(17)	–	11	62
Corporate and Other (i)	(518)	7	23	45	–	51	404
Total reportable segments	\$ 36,445	\$ 36,445	\$ 1,056	\$ 2,898	\$ 1,923	\$ 1,807	\$ 7,022
Current assets							10,163
Investments, intangible assets, goodwill, deferred tax assets and other assets							5,381
Consolidated total assets							\$ 22,566

2015							
	Total sales	External sales	Depreciation and amortization	Adjusted EBIT (ii)	Goodwill	Fixed asset additions	Fixed assets, net
North America							
Canada	\$ 6,329	\$ 5,856				\$ 242	\$ 645
United States	9,603	9,183				421	1,422
Mexico	4,261	3,869				233	755
Eliminations	(1,178)	–				–	–
North America	19,015	18,908	\$ 411	\$ 1,934	\$ 590	896	2,822
Europe							
Western Europe (excluding Great Britain)	8,936	8,635				357	1,263
Great Britain	404	404				26	145
Eastern Europe	2,110	1,873				112	471
Eliminations	(327)	–				–	–
Europe	11,123	10,912	276	451	525	495	1,879
Asia	1,981	1,846	77	149	229	121	811
Rest of World	461	461	17	(25)	–	15	51
Corporate and Other (i)	(446)	7	21	20	–	64	385
Total reportable segments	\$ 32,134	\$ 32,134	\$ 802	\$ 2,529	\$ 1,344	\$ 1,591	\$ 5,948
Current assets							11,144
Investments, intangible assets, goodwill, deferred tax assets, and other assets							2,595
Consolidated total assets							\$ 19,687

(i) Included in Corporate and Other Adjusted EBIT are intercompany fees charged to the automotive segments.

(ii) The following table reconciles Net income from continuing operations to Adjusted EBIT:

	2016	2015
Net Income from continuing operations	\$ 2,074	\$ 1,940
Add (deduct):		
Interest expense, net	88	44
Other expense (income), net	30	(166)
Income taxes	706	711
Adjusted EBIT	\$ 2,898	\$ 2,529

[b] The following table aggregates external revenues by customer as follows:

	2016	2015
General Motors	\$ 7,207	\$ 6,424
Ford Motor Company	5,667	4,923
Fiat / Chrysler Group	5,349	5,094
Daimler AG	4,294	3,779
BMW	3,786	3,300
Volkswagen	3,758	3,301
Other	6,384	5,313
	\$ 36,445	\$ 32,134

[c] The following table summarizes external revenues generated by automotive products and services:

	2016	2015
Body systems and chassis systems	\$ 9,157	\$ 7,790
Powertrain systems	6,489	4,755
Exterior systems	5,272	5,155
Seating systems	5,079	4,497
Tooling, engineering and other	3,078	2,700
Vision and electronic systems	2,768	2,583
Closure systems	2,412	2,297
Complete vehicle assembly	2,190	2,357
	\$ 36,445	\$ 32,134

MAGNA INTERNATIONAL INC.

Supplementary Financial and Share Information

FINANCIAL SUMMARY

(US dollars in millions, except per share figures)
(unaudited)

Years ended December 31,

	2016	2015	2014	2013	2012
Total sales	36,445	32,134	34,403	32,538	30,837
Depreciation and amortization	1,056	802	845	1,019	801
Net income attributable to Magna International Inc. from continuing operations	2,031	1,946	1,924	1,530	1,433
Diluted earnings per Common share from continuing operations	5.16	4.72	4.44	3.31	3.05
Weighted average number of Common shares outstanding - Diluted	393.2	412.7	433.2	461.6	470.4
Cash dividends paid per share	1.00	0.88	0.76	0.64	0.55
Cash flow from operations	3,386	2,332	2,822	2,502	2,206
Capital expenditures	1,807	1,591	1,495	1,094	1,274
Working capital	1,468	3,868	2,236	2,613	2,451
Fixed assets, net	7,022	5,948	5,402	5,189	5,273
Total assets	22,566	19,687	18,068	18,024	17,109
Long-term debt	2,394	2,327	806	102	112
Shareholders' equity	10,219	9,117	8,673	9,639	9,458
Long-term debt to equity ratio	0.23:1	0.26:1	0.09:1	0.01:1	0.01:1

All amounts are from continuing operations except the 2012 figures which have not been restated to reflect discontinued operations.

Share Information

The Common Shares are listed and traded in Canada on the Toronto Stock Exchange ("TSX") under the stock symbol "MG" and in the United States on the New York Stock Exchange ("NYSE") under the stock symbol "MGA". As of February 28, 2017, there were 1,392 registered holders of Common Shares.

Distribution of Shares held by Registered Shareholders

	Common Shares
Canada	80.67%
United States	19.26%
Other	0.07%

Dividends

Dividends for 2016 on Magna's Common Shares were paid on each of March 24, June 10, September 9 and December 9 at a rate of U.S.\$0.25. Magna's dividends have been designated as "eligible dividends" as defined in subsection 89(1) of the Income Tax Act (Canada) and, accordingly, are eligible for an enhanced tax credit. Additional details are found on Magna's website (www.magna.com), under "Investors – Shareholder Information – Dividends & Interest".

Price Range of Shares

The following table sets forth, for the years indicated, the high and low sales prices and volumes of Common Shares traded in each case as reported by the TSX and NYSE, respectively.

Quarter	Common Shares (TSX) (Cdn\$)			Stock Symbol "MG"		
	Year ended December 31, 2016			Year ended December 31, 2015		
	Volume	High	Low	Volume	High	Low
1st	88,185,636	56.47	42.09	34,520,227	69.71*	64.62
2nd	65,765,778	56.12	43.42	58,550,351	74.24	60.80
3rd	57,439,425	56.73	42.73	73,070,176	74.50	56.49
4th	63,141,400	62.10	49.44	69,201,347	71.10	55.96

Quarter	Common Shares (NYSE) (US\$)			Stock Symbol "MGA"		
	Year ended December 31, 2016			Year ended December 31, 2015		
	Volume	High	Low	Volume	High	Low
1st	164,022,753	40.94	34.04	45,981,685	55.61*	45.28
2nd	101,867,032	42.73	37.08	88,723,846	59.42	50.33
3rd	88,253,874	41.36	36.13	114,082,297	57.62	42.77
4th	88,039,428	44.20	39.08	114,739,117	53.89	40.31

* Price adjusted to reflect a two-for-one stock split implemented on March 25, 2015

(This page has been left blank intentionally.)

Corporate Directory

Directors

William L. Young (Chairman of the Board)

Scott B. Bonham

Peter G. Bowie

Hon. J. Trevor Eyton

Lady Barbara Judge

Dr. Kurt J. Lauk

Cynthia A. Niekamp

Dr. Indira V. Samarasekera

Donald J. Walker

Lawrence D. Worrall

Corporate Office

Magna International Inc.

337 Magna Drive
Aurora, Ontario
Canada L4G 7K1
Telephone: (905) 726-2462
magna.com

Transfer Agent and Registrar

Computershare Trust Company of Canada

100 University Avenue, 8th Floor
Toronto, Ontario, Canada M5J 2Y1
Telephone: 1 (800) 564-6253

Computershare Trust Company N.A.

250 Royall Street
Canton, MA, USA 02021
Telephone: (781) 575-3120
Toll Free: 1 (800) 962-4294
www.computershare.com

As a "foreign private issuer" listed on the New York Stock Exchange (NYSE), Magna is required to disclose the significant ways in which its corporate governance practices differ from those to be followed by U.S. domestic issuers under the NYSE listing standards. Please see the corporate governance section of our website (www.magna.com) for our Statement of Significant Corporate Governance Differences (NYSE). Additionally, please refer to the Management Information Circular/Proxy Statement for our 2017 Annual Meeting of Shareholders for a description of our corporate governance practices in comparison with the requirements and guidelines of the Canadian Securities Administrators.

Shareholders wishing to communicate with the non-management members of the Magna Board of Directors may do so by contacting the Chairman of the Board through the office of Magna's Corporate Secretary at 337 Magna Drive, Aurora, Ontario, Canada L4G 7K1 (905) 726-7070.

Shareholders wishing to obtain a copy of Magna's Notice of Intention to Make a Normal Course Issuer Bid, referred to in Note 20 to the consolidated financial statements contained in this Annual Report, may do so by contacting Magna's Corporate Secretary.

The 2017 Annual Meeting of Shareholders

The 2017 Annual Meeting of Shareholders will be held at Hilton Toronto/Markham Suites Conference Centre, 8500 Warden Avenue, Markham, Ontario, Canada on Thursday, May 11, 2017 commencing at 10:00 a.m. (Eastern Daylight Time).

2016 Annual Report

Additional copies of this 2016 Annual Report or copies of our quarterly reports may be obtained from: The Corporate Secretary, Magna International Inc., 337 Magna Drive, Aurora, Ontario, Canada L4G 7K1 or www.magna.com. Copies of financial data and other publicly filed documents are available through the internet on the Canadian Securities Administrators' System for Electronic Document Analysis and Retrieval (SEDAR) which can be accessed at www.sedar.com and on the United States Securities and Exchange Commission's Electronic Data Gathering, Analysis and Retrieval System (EDGAR), which can be accessed at www.sec.gov.

Executive Officers

Donald J. Walker
Chief Executive Officer

Vincent J. Galifi
Executive Vice-President
and Chief Financial Officer

Jeffrey O. Palmer
Executive Vice-President
and Chief Legal Officer

Guenther Apfalter
President, Magna Europe

Seetarama Kotagiri
Executive Vice-President,
Chief Technology Officer
and President, Magna Electronics

Marc J. Neeb
Executive Vice-President and
Chief Human Resources Officer

James J. Tobin, Sr.
Chief Marketing Officer
and President, Magna Asia

Tommy J. Skudutis
Chief Operating Officer, Exteriors,
Seating, Mirrors, Closures
and Cosma

Frank C. Seguin
Executive Vice-President,
Corporate Projects and
Strategy Development

Exchange Listings

Common Shares

Toronto Stock Exchange **MG**
New York Stock Exchange **MGA**



DRIVING **EXCELLENCE.**
INSPIRING **INNOVATION.**

MAGNA INTERNATIONAL INC.

337 Magna Drive

Aurora, Ontario, Canada L4G 7K1

Telephone: +1 905 726 2462

magna.com

CONNECT WITH MAGNA

